

# DS

**DARTERS SURGICAL**  
Laparoscopy Catalog

WE DESIGN, MANUFACTURE & SELL THE TOOLS THE SURGEONS USE



## CONTACT US



Head Marala Road, Sialkot-Pakistan



[info@dartersurgical.com](mailto:info@dartersurgical.com)



0092-305-6056248



[www.dartersurgical.com](http://www.dartersurgical.com)

**OFFERED IN 3 STYLES:**

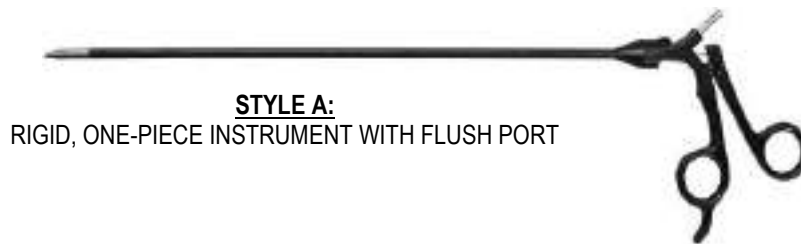

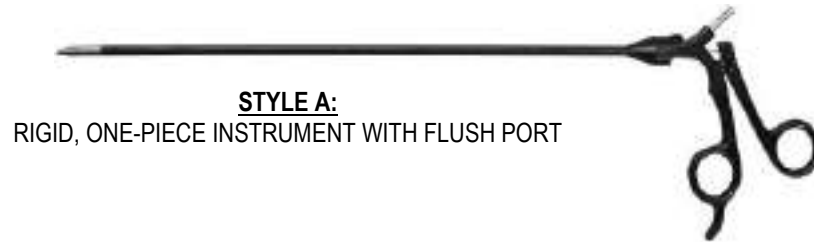

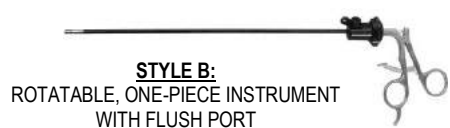

	<u>Length</u>	<u>Style A:</u>	<u>Style B:</u>
5MM Ø, MICRO REDDICK-OLSEN GRASPER/DISSECTOR	33 CM	52255-01A	52255-01B
	36 CM	52236-01A	52236-01B
	45 CM	52155-01A	52155-01B
	24 CM	52224-01A	52224-01B
5MM Ø, STANDARD GRASPER/DISSECTOR WITH SPOON	33 CM	52255-02A	52255-02B
	36 CM	52236-02A	52236-02B
	45 CM	52155-02A	52155-02B
	24 CM	52224-02A	52224-02B
5MM Ø, STANDARD GRASPER/DISSECTOR W/ SPOON, LONG 20 MM JAW	52255-01A	52255-52A	52255-52B
	52236-01A	52236-52A	52236-52B
	52155-01A	52155-52A	52155-52B
	52224-01A	52224-52A	52224-52B
5MM Ø, STANDARD GRASPER/DISSECTOR	33 CM	52255-03A	52255-03B
	36 CM	52236-03A	52236-03B
	45 CM	52155-03A	52155-03B
	24 CM	52224-03A	52224-03B
5MM Ø, BULLET-NOSE GRASPER/DISSECTOR WITH SPOON	33 CM	52255-04A	52255-04B
	36 CM	52236-04A	52236-04B
	45 CM	52155-04A	52155-04B
	24 CM	52224-04A	52224-04B
5MM Ø, TAPERED DOLPHIN-NOSE GRASPER/DISSECTOR	33 CM	52255-05A	52255-05B
	36 CM	52236-05A	52236-05B
	45 CM	52155-05A	52155-05B
	24 CM	52224-05A	52224-05B
5MM Ø, TAPERED DOLPHIN-NOSE GRASPER/DISSECTOR W/ SPOON	33 CM	52255-105A	52255-105B
	36 CM	52236-105A	52236-105B
	45 CM	52155-105A	52155-105B
	24 CM	52224-105A	52224-105B
5MM Ø, MARYLAND GRASPER/DISSECTOR, 18MM LENGTH TIP	33 CM	52255-06A	52255-06B
	36 CM	52236-06A	52236-06B
	45 CM	52155-06A	52155-06B
	24 CM	52224-06A	52224-06B
5MM Ø, TAPERED MARYLAND GRASPER/DISSECTOR, 18MM LENGTH TIP	33 CM	52255-99A	52255-99B
	36 CM	52236-99A	52236-99B
	45 CM	52155-99A	52155-99B
	24 CM	52224-99A	52224-99B
5MM Ø, SHORT MARYLAND GRASPER/DISSECTOR, 15MM LENGTH TIP	33 CM	52255-91A	52255-91B
	36 CM	52236-91A	52236-91B
	45 CM	52155-91A	52155-91B
	24 CM	52224-91A	52224-91B



<u>Recommended</u>	<u>Optional</u>
	
<i>Type 1: Insulated Stainless Steel w/ RF Post</i>	<i>Type 3: Non-Insulated Stainless Steel</i>
<b>OR</b>	
	<i>Type 7: Lightweight Carbon-Fiber w/ RF Post, Ratchet / Ratchet Defeating</i>
<i>Type 5: Lightweight Carbon -Fiber w/ RF Post</i>	
<b>OR</b>	<i>Type 9: Lightweight Carbon-Fiber w/ RF Post, w/ Large Finger Loops</i>
	
<i>Type 17: Lightweight Carbon -Fiber w/ RF Post</i>	<i>Type 18: Carbon-Fiber w/ RF Post, Ratchet / Ratchet Defeating</i>

We offer complete solution for Electrosurgical Accessories for hospital at the right price.



**STYLE A:**  
RIGID, ONE-PIECE INSTRUMENT WITH FLUSH PORT

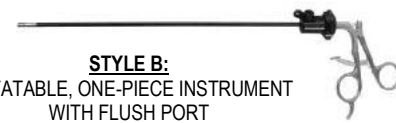

**STYLE B:**  
ROTATABLE, ONE-PIECE INSTRUMENT WITH FLUSH PORT



	<u>Length</u>	<u>Style A:</u>	<u>Style B:</u>
5MM Ø, MIXTER GRASPER/ DISSECTOR RIGHT ANGLE (LONG)	33 CM	52255-07A	52255-07B
	36 CM	52236-07A	52236-07B
	45 CM	52155-07A	52155-07B
	24 CM	52224-07A	52224-07B
5MM Ø, MIXTER GRASPER/ DISSECTOR, SHORT RIGHT ANGLE	33 CM	52255-59A	52255-59B
	36 CM	52236-59A	52236-59B
	45 CM	52155-59A	52155-59B
	24 CM	52224-59A	52224-59B
5MM Ø, MIXTER GRASPER/ DISSECTOR 45 DEGREE ANGLE	33 CM	52255-08A	52255-08B
	36 CM	52236-08A	52236-08B
	45 CM	52155-08A	52155-08B
	24 CM	52224-08A	52224-08B
5MM Ø, DUCKBILL GRASPER/ DISSECTOR	33 CM	52255-09A	52255-09B
	36 CM	52236-09A	52236-09B
	45 CM	52155-09A	52155-09B
	24 CM	52224-09A	52224-09B
5MM Ø, NEEDLE-NOSE GRASPER/DISSECTOR	33 CM	52255-10A	52255-10B
	36 CM	52236-10A	52236-10B
	45 CM	52155-10A	52155-10B
	24 CM	52224-10A	52224-10B
5MM Ø, KELLY GRASPER/ DISSECTOR	33 CM	52255-11A	52255-11B
	36 CM	52236-11A	52236-11B
	45 CM	52155-11A	52155-11B
	24 CM	52224-11A	52224-11B
5MM Ø, LONG REACH, RIGHT ANGLE DISSECTOR, DBL- ACTION (REQUIRES LARGER CANNULA)	33 CM	52255-53A	52255-53B
	36 CM	52236-53A	52236-53B
	45 CM	52155-53A	52155-53B
	24 CM	52224-53A	52224-53B
5MM Ø, PETELIN DISSECTOR, 60 DEG. ANGLE LEFT, SINGLE-ACTION	33 CM	52255-12A	52255-12B
	36 CM	52236-12A	52236-12B
	45 CM	52155-12A	52155-12B
	24 CM	52224-12A	52224-12B
5MM Ø, PETELIN DISSECTOR, 30 DEG. ANGLE LEFT, SINGLE- ACTION	33 CM	52255-13A	52255-13B
	36 CM	52236-13A	52236-13B
	45 CM	52155-13A	52155-13B
	24 CM	52224-13A	52224-13B
5MM Ø, MICRO GRASPER/ DISSECTOR, FENESTRATED	33 CM	52255-14A	52255-14B
	36 CM	52236-14A	52236-14B
	45 CM	52155-14A	52155-14B
	24 CM	52224-14A	52224-14B

Recommended

Optional



Type 1:  
Insulated Stainless  
Steel w/ RF Post

**OR**



Type 5:  
Lightweight Carbon  
-Fiber w/ RF Post

**OR**



Type 17:  
Lightweight Carbon  
-Fiber w/ RF Post



Type 3:  
Non-Insulated  
Stainless Steel



Type 7:  
Lightweight  
Carbon-Fiber w/  
RF Post, Ratchet /  
Ratchet Defeating



Type 9:  
Lightweight  
Carbon-Fiber w/  
RF Post, w/ Large  
Finger Loops



Type 18:  
Carbon-Fiber w/  
RF Post, Ratchet /  
Ratchet Defeating

We offer complete solution for Electrosurgical Accessories for hospital at the right price.

**STYLE A:**  
RIGID, ONE-PIECE INSTRUMENT WITH  
FLUSH PORT



**STYLE B:**  
ROTATABLE, ONE-PIECE INSTRUMENT  
WITH FLUSH PORT

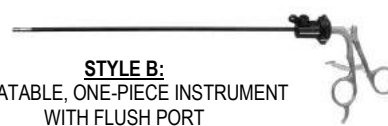

	<u>Length</u>	<u>Style A:</u>	<u>Style B:</u>
5MM Ø, COBRA GRASPER, DOUBLE-ACTION	33 CM	52255-15A	52255-15B
	36 CM	52236-15A	52236-15B
	45 CM	52155-15A	52155-15B
	24 CM	52224-15A	52224-15B
5MM Ø, BABCOCK GRASPER, FENESTRATED TIP	33 CM	52255-16A	52255-16B
	36 CM	52236-16A	52236-16B
	45 CM	52155-16A	52155-16B
	24 CM	52224-16A	52224-16B
5MM Ø, BABCOCK GRASPER, AXIS STYLE, FENESTRATED TIP	33 CM	52255-116A	52255-116B
	36 CM	52236-116A	52236-116B
	45 CM	52155-116A	52155-116B
	24 CM	52224-116A	52224-116B
5MM Ø, BABCOCK GRASPER- SHORT: DELICATE APPLICATION	33 CM	52255-17A	52255-17B
	36 CM	52236-17A	52236-17B
	45 CM	52155-17A	52155-17B
	24 CM	52224-17A	52224-17B
5MM Ø, ALLIS GRASPER, SHORT VERSION, SINGLE ACTION	33 CM	52255-18A	52255-18B
	36 CM	52236-18A	52236-18B
	45 CM	52155-18A	52155-18B
	24 CM	52224-18A	52224-18B
5MM Ø, ALLIS GRASPER, SHORT VERSION, 3 X 4 TEETH, SERRATED, DOUBLE- ACTION	33 CM	52255-19A	52255-19B
	36 CM	52236-19A	52236-19B
	45 CM	52155-19A	52155-19B
	24 CM	52224-19A	52224-19B
5MM Ø, ATRAUMATIC ALLIS GRASPER, SHORT VERSION, SERRATED W/ DOUBLE ROW OF TEETH, DOUBLE-ACTION	33 CM	52255-119A	52255-119B
	36 CM	52236-119A	52236-119B
	45 CM	52155-119A	52155-119B
	24 CM	52224-119A	52224-119B
5MM Ø, ATRAUMATIC ALLIS GRASPER, LONG VERSION, SERRATED W/ DOUBLE ROW OF TEETH, DOUBLE-ACTION	33 CM	52255-219A	52255-219B
	36 CM	52236-219A	52236-219B
	45 CM	52155-219A	52155-219B
	24 CM	52224-219A	52224-219B
5MM Ø, ALLIS GRASPER, MEDIUM VERSION, (WECK STYLE)	33 CM	52255-20A	52255-20B
	36 CM	52236-20A	52236-20B
	45 CM	52155-20A	52155-20B
	24 CM	52224-20A	52224-20B
5MM Ø, ALLIS GRASPER, STANDARD VERSION	33 CM	52255-21A	52255-21B
	36 CM	52236-21A	52236-21B
	45 CM	52155-21A	52155-21B
	24 CM	52224-21A	52224-21B

**Recommended**

**Optional**



Type 2:  
Insulated Stainless  
Steel w/ RF Post &  
Ratchet

Type 4:  
Non-Insulated  
Stainless Steel w/  
Ratchet

OR



Type 7:  
Lightweight  
Carbon-Fiber w/  
RF Post, Ratchet /  
Ratchet Defeating



Type 6:  
Lightweight Carbon  
-Fiber w/ RF Post  
& Ratchet



OR

Type 8:  
Lightweight  
Carbon-Fiber w/  
RF Post, French  
On/Off Ratchet



Type 9:  
Lightweight  
Carbon-Fiber w/  
RF Post, Ratchet /  
Ratchet Defeating  
w/ Large Finger  
Loops



Type 18:  
Carbon-Fiber w/  
RF Post, Ratchet /  
Ratchet Defeating



**STYLE A:**  
RIGID, ONE-PIECE INSTRUMENT WITH FLUSH PORT

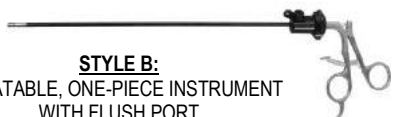

**STYLE B:**  
ROTATABLE, ONE-PIECE INSTRUMENT WITH FLUSH PORT



	<u>Length</u>	<u>Style A:</u>	<u>Style B:</u>
5MM Ø, TC ALLIS, STANDARD VERSION	33 CM	52255-57A	52255-57B
	36 CM	52236-57A	52236-57B
	45 CM	52155-57A	52155-57B
	24 CM	52224-57A	52224-57B
5MM Ø, DEBAKEY GRASPER, 20 MM JAW LENGTH	33 CM	52255-22A	52255-22B
	36 CM	52236-22A	52236-22B
	45 CM	52155-22A	52155-22B
	24 CM	52224-22A	52224-22B
5MM Ø, DEBAKEY GRASPER, 40 MM JAW LENGTH	33 CM	52255-23A	52255-23B
	36 CM	52236-23A	52236-23B
	45 CM	52155-23A	52155-23B
	24 CM	52224-23A	52224-23B
5MM Ø, HUNTER/ FENESTRATED DEBAKEY GRASPER, 20 MM JAW LENGTH	33 CM	52255-58A	52255-58B
	36 CM	52236-58A	52236-58B
	45 CM	52155-58A	52155-58B
	24 CM	52224-58A	52224-58B
5MM Ø, HUNTER/ FENESTRATED DEBAKEY GRASPER, 40 MM JAW LENGTH	33 CM	52255-159A	52255-159B
	36 CM	52236-159A	52236-159B
	45 CM	52155-159A	52155-159B
	24 CM	52224-159A	52224-159B
5MM Ø, HUNTER/ FENESTRATED DEBAKEY GRASPER, 60 MM JAW LENGTH	33 CM	52255-160A	52255-160B
	36 CM	52236-160A	52236-160B
	45 CM	52155-160A	52155-160B
	24 CM	52224-160A	52224-160B
5MM Ø, DEBAKEY CURVED GRASPER, w/ ATRAUMATIC TEETH, DOUBLE-ACTION	33 CM	52255-46A	52255-46B
	36 CM	52236-46A	52236-46B
	45 CM	52155-46A	52155-46B
	24 CM	52224-46A	52224-46B
5MM Ø, GLASSMAN ATRAUMATIC GRASPER	33 CM	52255-24A	52255-24B
	36 CM	52236-24A	52236-24B
	45 CM	52155-24A	52155-24B
	24 CM	52224-24A	52224-24B
5MM Ø, ATRAUMATIC GRASPER, CROSS SERRATED	33 CM	52255-25A	52255-25B
	36 CM	52236-25A	52236-25B
	45 CM	52155-25A	52155-25B
	24 CM	52224-25A	52224-25B
5MM Ø, DOUBLE CUP FUNDUS MAXI GRASPER	33 CM	52255-26A	52255-26B
	36 CM	52236-26A	52236-26B
	45 CM	52155-26A	52155-26B
	24 CM	52224-26A	52224-26B

Recommended

Optional



Type 2:  
Insulated Stainless Steel w/ RF Post & Ratchet

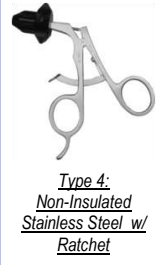

Type 4:  
Non-Insulated Stainless Steel w/ Ratchet

OR



Type 6:  
Lightweight Carbon-Fiber w/ RF Post & Ratchet



Type 7:  
Lightweight Carbon-Fiber w/ RF Post, Ratchet / Ratchet Defeating

OR



Type 8:  
Lightweight Carbon-Fiber w/ RF Post, French On/Off Ratchet



Type 9:  
Lightweight Carbon-Fiber w/ RF Post, Ratchet / Ratchet Defeating w/ Large Finger Loops



Type 18:  
Carbon-Fiber w/ RF Post, Ratchet / Ratchet Defeating

We offer complete solution for Electrosurgical Accessories for hospital at the right price.



**STYLE A:**  
RIGID, ONE-PIECE INSTRUMENT WITH FLUSH PORT



**STYLE B:**  
ROTATABLE, ONE-PIECE INSTRUMENT WITH FLUSH PORT



	<u>Length</u>	<u>Style A:</u>	<u>Style B:</u>
5MM Ø, "WINER" STYLE FUNDUS MAXI GRASPER	33 CM	52255-326A	52255-326B
	36 CM	52236-326A	52236-326B
	45 CM	52155-326A	52155-326B
	24 CM	52224-326A	52224-326B
5MM Ø, "MCKERNAN" STYLE FUNDUS MAXI GRASPER	33 CM	52255-126A	52255-126B
	36 CM	52236-126A	52236-126B
	45 CM	52155-126A	52155-126B
	24 CM	52224-126A	52224-126B
5MM Ø, DOUBLE CUP FENESTRATED FUNDUS MAXI GRASPER	33 CM	52255-226A	52255-226B
	36 CM	52236-226A	52236-226B
	45 CM	52155-226A	52155-226B
	24 CM	52224-226A	52224-226B
5MM Ø, ENDO CLINCH FENESTRATED GRASPER	33 CM	52255-27A	52255-27B
	36 CM	52236-27A	52236-27B
	45 CM	52155-27A	52155-27B
	24 CM	52224-27A	52224-27B
5MM Ø, RETRO FACING RAT-TOOTH GRASPER w/ ATRAUMATIC CUP	33 CM	52255-28A	52255-28B
	36 CM	52236-28A	52236-28B
	45 CM	52155-28A	52155-28B
	24 CM	52224-28A	52224-28B
5MM Ø, ALLIGATOR GRASPER, 10MM JAW, RETRO FACING TEETH, DBL-ACTION	33 CM	52255-29A	52255-29B
	36 CM	52236-29A	52236-29B
	45 CM	52155-29A	52155-29B
	24 CM	52224-29A	52224-29B
5MM Ø, ALLIGATOR GRASPER, 20MM JAW, RETRO FACING TEETH, DBL-ACTION	33 CM	52255-129A	52255-129B
	36 CM	52236-129A	52236-129B
	45 CM	52155-129A	52155-129B
	24 CM	52224-129A	52224-129B
5MM Ø, ALLIGATOR GRASPER, RETRO FACING TEETH, SINGLE-ACTION	33 CM	52255-30A	52255-30B
	36 CM	52236-30A	52236-30B
	45 CM	52155-30A	52155-30B
	24 CM	52224-30A	52224-30B
5MM Ø, CUP SHAPED GRASPER WITH RETRO FACING TEETH, DBL-ACTION	33 CM	52255-58A	52255-58B
	36 CM	52236-58A	52236-58B
	45 CM	52155-58A	52155-58B
	24 CM	52224-58A	52224-58B
5MM Ø, WAVE GRASPER, LONG BEVELED EDGE JAW, DBL-ACTION	33 CM	52255-32A	52255-32B
	36 CM	52236-32A	52236-32B
	45 CM	52155-32A	52155-32B
	24 CM	52224-32A	52224-32B

Recommended

Optional



Type 2:  
Insulated Stainless Steel w/ RF Post & Ratchet

OR



Type 6:  
Lightweight Carbon-Fiber w/ RF Post & Ratchet

OR



Type 9:  
Lightweight Carbon-Fiber w/ RF Post, Ratchet / Ratchet Defeating w/ Large Finger Loops



Type 4:  
Non-Insulated Stainless Steel w/ Ratchet



Type 7:  
Lightweight Carbon-Fiber w/ RF Post, Ratchet / Ratchet Defeating



Type 8:  
Lightweight Carbon-Fiber w/ RF Post, French On/Off Ratchet



Type 18:  
Carbon-Fiber w/ RF Post, Ratchet / Ratchet Defeating





**STYLE A:**  
RIGID, ONE-PIECE INSTRUMENT WITH FLUSH PORT



**STYLE B:**  
ROTATABLE, ONE-PIECE INSTRUMENT WITH FLUSH PORT



	<u>Length</u>	<u>Style A:</u>	<u>Style B:</u>
5MM Ø, WAVE GRASPER, LONG BEVELED EDGE JAW, SINGLE ACTION	33 CM	52255-33A	52255-33B
	36 CM	52236-33A	52236-33B
	45 CM	52155-33A	52155-33B
	24 CM	52224-33A	52224-33B
5MM Ø, CLAW GRASPER, 2 X 3 TEETH, SINGLE-ACTION	33 CM	52255-36A	52255-36B
	36 CM	52236-36A	52236-36B
	45 CM	52155-36A	52155-36B
	24 CM	52224-36A	52224-36B
5MM Ø, CLAW GRASPER, 2 X 3 TEETH, W/ EXTRA ROW OF TEETH, DOUBLE-ACTION	33 CM	52255-136A	52255-136B
	36 CM	52236-136A	52236-136B
	45 CM	52155-136A	52155-136B
	24 CM	52224-136A	52224-136B
5MM Ø, RETRACTION GRASPER, LONG RIDGED JAWS, 2 X 3 ATRAUMATIC TEETH, DOUBLE-ACTION	33 CM	52255-34A	52255-34B
	36 CM	52236-34A	52236-34B
	45 CM	52155-34A	52155-34B
	24 CM	52224-34A	52224-34B
5MM Ø, RETRACTION GRASPER, LONG RIDGED JAWS, 2 X 3 ATRAUMATIC TEETH, SINGLE-ACTION	33 CM	52255-35A	52255-35B
	36 CM	52236-35A	52236-35B
	45 CM	52155-35A	52155-35B
	24 CM	52224-35A	52224-35B
5MM Ø, RETRACTION GRASPER, 2 X 3 ATRAUMATIC TEETH, DOUBLE-ACTION (JARIT STYLE)	33 CM	52255-134A	52255-134B
	36 CM	52236-134A	52236-134B
	45 CM	52155-134A	52155-134B
	24 CM	52224-134A	52224-134B
5MM Ø, RETRACTION GRASPER, 2 X 3 ATRAUMATIC TEETH, SINGLE-ACTION (JARIT STYLE)	33 CM	52255-135A	52255-135B
	36 CM	52236-135A	52236-135B
	45 CM	52155-135A	52155-135B
	24 CM	52224-135A	52224-135B
5MM Ø, ATRAUMATIC FENESTRATED GRASPER, CURVED, 16 MM DBL-ACTION JAW	33 CM	52255-37A	52255-37B
	36 CM	52236-37A	52236-37B
	45 CM	52155-37A	52155-37B
	24 CM	52224-37A	52224-37B
5MM Ø, FENESTRATED GRASPER, 16 MM DBL-ACTION JAW	33 CM	52255-38A	52255-38B
	36 CM	52236-38A	52236-38B
	45 CM	52155-38A	52155-38B
	24 CM	52224-38A	52224-38B
5MM Ø, FENESTRATED GRASPER, 20 MM DBL-ACTION JAW	33 CM	52255-39A	52255-39B
	36 CM	52236-39A	52236-39B
	45 CM	52155-39A	52155-39B
	24 CM	52224-39A	52224-39B

Recommended

Optional



Type 2:  
Insulated Stainless Steel w/ RF Post & Ratchet

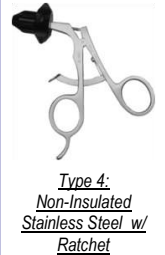

Type 4:  
Non-Insulated Stainless Steel w/ Ratchet

OR



Type 6:  
Lightweight Carbon-Fiber w/ RF Post & Ratchet



Type 7:  
Lightweight Carbon-Fiber w/ RF Post, Ratchet / Ratchet Defeating

OR



Type 9:  
Lightweight Carbon-Fiber w/ RF Post, Ratchet / Ratchet Defeating w/ Large Finger Loops



Type 8:  
Lightweight Carbon-Fiber w/ RF Post, French On/Off Ratchet



Type 18:  
Carbon-Fiber w/ RF Post, Ratchet / Ratchet Defeating

We offer complete solution for Electrosurgical Accessories for hospital at the right price.



**STYLE A:**  
RIGID, ONE-PIECE INSTRUMENT WITH  
FLUSH PORT



**STYLE B:**  
ROTATABLE, ONE-PIECE INSTRUMENT  
WITH FLUSH PORT



	<u>Length</u>	<u>Style A:</u>	<u>Style B:</u>
5MM Ø, FENESTRATED GRASPER, 40 MM DBL-ACTION JAW	33 CM	52255-40A	52255-40B
	36 CM	52236-40A	52236-40B
	45 CM	52155-40A	52155-40B
	24 CM	52224-40A	52224-40B
5MM Ø, JOHAN FENESTRATED GRASPER, 22 MM SINGLE-ACTION FLAT JAWS	33 CM	52255-41A	52255-41B
	36 CM	52236-41A	52236-41B
	45 CM	52155-41A	52155-41B
	24 CM	52224-41A	52224-41B
5MM Ø, JOHAN FENESTRATED GRASPER, 45 MM SGL-ACTION FLAT JAWS	33 CM	52255-42A	52255-42B
	36 CM	52236-42A	52236-42B
	45 CM	52155-42A	52155-42B
	24 CM	52224-42A	52224-42B
5MM Ø, KOCHER GRASPER, 1 X 2 TEETH, SINGLE-ACTION FLAT JAWS	33 CM	52255-43A	52255-43B
	36 CM	52236-43A	52236-43B
	45 CM	52155-43A	52155-43B
	24 CM	52224-43A	52224-43B
5MM Ø, KOCHER GRASPER, 1 X 2 TEETH, DOUBLE-ACTION (WECK TYPE)	33 CM	52255-44A	52255-44B
	36 CM	52236-44A	52236-44B
	45 CM	52155-44A	52155-44B
	24 CM	52224-44A	52224-44B
5MM Ø, SCHROEDER TENACULUM GRASPER, SINGLE TEETH	33 CM	52255-45A	52255-45B
	36 CM	52236-45A	52236-45B
	45 CM	52155-45A	52155-45B
	24 CM	52224-45A	52224-45B
5MM Ø, SCHROEDER TENACULUM GRASPER, SINGLE TEETH w/ EXTRA GUIDE TOOTH	33 CM	52255-94A	52255-94B
	36 CM	52236-94A	52236-94B
	45 CM	52155-94A	52155-94B
	24 CM	52224-94A	52224-94B
5MM Ø, BLUNT ATRAUMATIC GRASPING FORCEPS, DOUBLE-ACTION	33 CM	52255-47A	52255-47B
	36 CM	52236-47A	52236-47B
	45 CM	52155-47A	52155-47B
	24 CM	52224-47A	52224-47B
5MM Ø, BLUNT ATRAUMATIC GRASPER W/ CROSS-SERRATED TIPS, DBL-ACTION	33 CM	52255-56A	52255-56B
	36 CM	52236-56A	52236-56B
	45 CM	52155-56A	52155-56B
	24 CM	52224-56A	52224-56B
5MM Ø, BULLET NOSE GRASPER/DISSECTOR, TC, MICRO DIAMOND JAW PATTERN DOUBLE-ACTION	33 CM	52255-48A	52255-48B
	36 CM	52236-48A	52236-48B
	45 CM	52155-48A	52155-48B
	24 CM	52224-48A	52224-48B

Recommended

Optional



Type 2:  
*Insulated Stainless Steel w/ RF Post & Ratchet*



Type 4:  
*Non-Insulated Stainless Steel w/ Ratchet*

OR



Type 6:  
*Lightweight Carbon-Fiber w/ RF Post & Ratchet*



Type 7:  
*Lightweight Carbon-Fiber w/ RF Post, Ratchet / Ratchet Defeating*

OR



Type 9:  
*Lightweight Carbon-Fiber w/ RF Post, Ratchet / Ratchet Defeating w/ Large Finger Loops*



Type 8:  
*Lightweight Carbon-Fiber w/ RF Post, French On/Off Ratchet*



Type 18:  
*Carbon-Fiber w/ RF Post, Ratchet / Ratchet Defeating*



**STYLE A:**  
RIGID, ONE-PIECE INSTRUMENT WITH FLUSH PORT

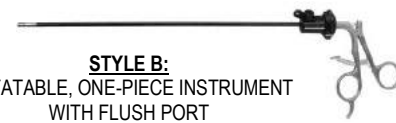

**STYLE B:**  
ROTATABLE, ONE-PIECE INSTRUMENT WITH FLUSH PORT



	<u>Length</u>	<u>Style A:</u>	<u>Style B:</u>
5MM Ø, BULLET NOSE GRASPER/DISSECTOR, TC, CROSS DIAMOND JAW PATTERN DOUBLE-ACTION	33 CM	52255-49A	52255-49B
	36 CM	52236-49A	52236-49B
	45 CM	52155-49A	52155-49B
	24 CM	52224-49A	52224-49B
5MM Ø, LONG TAPERED GRASPER W/ ATRAUMATIC TEETH, DBL-ACTION	33 CM	52255-51A	52255-51B
	36 CM	52236-51A	52236-51B
	45 CM	52155-51A	52155-51B
	24 CM	52224-51A	52224-51B
5MM Ø, WAVE GRASPER, POINTED, SINGLE-ACTION	33 CM	52255-54A	52255-54B
	36 CM	52236-54A	52236-54B
	45 CM	52155-54A	52155-54B
	24 CM	52224-54A	52224-54B
5MM Ø, WAVE GRASPER, BLUNT, SINGLE-ACTION	33 CM	52255-55A	52255-55B
	36 CM	52236-55A	52236-55B
	45 CM	52155-55A	52155-55B
	24 CM	52224-55A	52224-55B
5MM Ø, "DAVOL" TYPE, ATRAUMATIC GRASPER, SCOOPED-OUT JAW & GENTLY MASHING TEETH	33 CM	52255-90A	52255-90B
	36 CM	52236-90A	52236-90B
	45 CM	52155-90A	52155-90B
	24 CM	52224-90A	52224-90B
5MM Ø, "ACCESS" TYPE, FENESTRATED GRASPER, 20MM JAW W/ AGGRESSIVE TEETH FOR POSITIVE EXTRA STRONG TISSUE HOLDING	33 CM	52255-91A	52255-91B
	36 CM	52236-91A	52236-91B
	45 CM	52155-91A	52155-91B
	24 CM	52224-91A	52224-91B
5MM Ø, "SOFT TOUCH" GRASPER, 22 MM JAW, ATRAUMATIC TEFLON INSERTS FOR THE LIGHT MINIMUM TISSUE TRAUMA TOUCH YET POSITIVE HOLDING	33 CM	52255-144A	52255-144B
	36 CM	52236-144A	52236-144B
	45 CM	52155-144A	52155-144B
	24 CM	52224-144A	52224-144B
5MM Ø, "SOFT TOUCH" GRASPER, 40 MM JAW, ATRAUMATIC TEFLON INSERTS FOR THE LIGHT MINIMUM TISSUE TRAUMA TOUCH YET POSITIVE HOLDING	33 CM	52255-145A	52255-145B
	36 CM	52236-145A	52236-145B
	45 CM	52155-145A	52155-145B
	24 CM	52224-145A	52224-145B

Recommended

Optional



Type 2:  
Insulated Stainless Steel w/ RF Post & Ratchet



Type 4:  
Non-Insulated Stainless Steel w/ Ratchet

OR



Type 6:  
Lightweight Carbon-Fiber w/ RF Post & Ratchet



Type 7:  
Lightweight Carbon-Fiber w/ RF Post, Ratchet / Ratchet Defeating

OR



Type 9:  
Lightweight Carbon-Fiber w/ RF Post, Ratchet / Ratchet Defeating w/ Large Finger Loops



Type 8:  
Lightweight Carbon-Fiber w/ RF Post, French On/Off Ratchet



Type 18:  
Carbon-Fiber w/ RF Post, Ratchet / Ratchet Defeating

**STYLE A:**  
RIGID, ONE-PIECE INSTRUMENT WITH  
FLUSH PORT



**STYLE B:**  
ROTATABLE, ONE-PIECE INSTRUMENT  
WITH FLUSH PORT

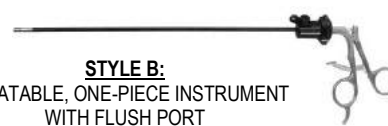

	<u>Length</u>	<u>Style A:</u>	<u>Style B:</u>
5MM Ø, HOOK SCISSORS, SINGLE-ACTION	33 CM	52255-60A	52255-60B
	36 CM	52236-60A	52236-60B
	45 CM	52155-60A	52155-60B
	24 CM	52224-60A	52224-60B
5MM Ø, MICRO TIP SCISSORS, STRAIGHT, SINGLE-ACTION	33 CM	52255-61A	52255-61B
	36 CM	52236-61A	52236-61B
	45 CM	52155-61A	52155-61B
	24 CM	52224-61A	52224-61B
5MM Ø, MICRO TIP SCISSORS, CURVED, SINGLE-ACTION	33 CM	52255-62A	52255-62B
	36 CM	52236-62A	52236-62B
	45 CM	52155-62A	52155-62B
	24 CM	52224-62A	52224-62B
5MM Ø, METZENBAUM SCISSORS, STRAIGHT, LONG BLADE (20MM TIP)	33 CM	52255-63A	52255-63B
	36 CM	52236-63A	52236-63B
	45 CM	52155-63A	52155-63B
	24 CM	52224-63A	52224-62B
5MM Ø, METZENBAUM SCISSORS, STRAIGHT, SHORT BLADE (12MM TIP)	33 CM	52255-64A	52255-64B
	36 CM	52236-64A	52236-64B
	45 CM	52155-64A	52155-64B
	24 CM	52224-64A	52224-64B
5MM Ø, METZENBAUM SCISSORS, CURVED, LONG BLADE (18MM TIP)	33 CM	52255-65A	52255-65B
	36 CM	52236-65A	52236-65B
	45 CM	52155-65A	52155-65B
	24 CM	52224-65A	52224-65B
5MM Ø, METZENBAUM SCISSORS, HARDENED STEEL, CURVED BLADE (16MM TIP)	33 CM	52255-66A	52255-66B
	36 CM	52236-66A	52236-66B
	45 CM	52155-66A	52155-66B
	24 CM	52224-66A	52224-66B
5MM Ø, METZENBAUM SCISSORS, CURVED, SHORT BLADE (11MM TIP)	33 CM	52255-166A	52255-166B
	36 CM	52236-166A	52236-166B
	45 CM	52155-166A	52155-166B
	24 CM	52224-166A	52224-166B
5MM Ø, PERITONEAL SCISSORS, SINGLE-ACTION	33 CM	52255-67A	52255-67B
	36 CM	52236-67A	52236-67B
	45 CM	52155-67A	52155-67B
	24 CM	52224-67A	52224-67B
5MM Ø, HOOK SCISSORS, TS, EXTRA HARD STEEL	33 CM	52255-76A	52255-76B
	36 CM	52236-76A	52236-76B
	45 CM	52155-76A	52155-76B
	24 CM	52224-76A	52224-76B

Recommended

Optional



Type 1:  
Insulated Stainless  
Steel w/ RF Post

OR



Type 5:  
Lightweight Carbon  
-Fiber w/ RF Post

OR



Type 17:  
Lightweight Carbon  
-Fiber w/ RF Post



Type 3:  
Non-Insulated  
Stainless Steel



Type 7:  
Lightweight  
Carbon-Fiber w/  
RF Post, Ratchet /  
Ratchet Defeating



Type 9:  
Lightweight  
Carbon-Fiber w/  
RF Post, w/ Large  
Finger Loops



Type 18:  
Carbon-Fiber w/  
RF Post, Ratchet /  
Ratchet Defeating

We offer complete solution for Electrosurgical Accessories for hospital at the right price.



**STYLE A:**  
RIGID, ONE-PIECE INSTRUMENT WITH FLUSH PORT

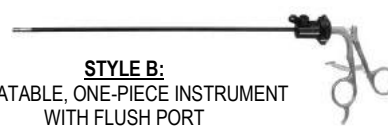

**STYLE B:**  
ROTATABLE, ONE-PIECE INSTRUMENT WITH FLUSH PORT



	<u>Length</u>	<u>Style A:</u>	<u>Style B:</u>
5MM Ø, PERITONEAL SCISSORS, TS, EXTRA HARD STEEL, SINGLE-ACTION	33 CM	52255-77A	52255-77B
	36 CM	52236-77A	52236-77B
	45 CM	52155-77A	52155-77B
	24 CM	52224-77A	52224-77B
5MM Ø, PERITONEAL SCISSORS, TS, EXTRA HARD STEEL, DOUBLE-ACTION	33 CM	52255-78A	52255-78B
	36 CM	52236-78A	52236-78B
	45 CM	52155-78A	52155-78B
	24 CM	52224-78A	52224-78B
5MM Ø, BIOPSY SPOON FORCEPS W/ TOOTH, (SEMM-TYPE) SINGLE-ACTION	33 CM	52255-79A	52255-79B
	36 CM	52236-79A	52236-79B
	45 CM	52155-79A	52155-79B
	24 CM	52224-79A	52224-79B
5MM Ø, BIOPSY SPOON FORCEPS, SINGLE-ACTION	33 CM	52255-69A	52255-69B
	36 CM	52236-69A	52236-69B
	45 CM	52155-69A	52155-69B
	24 CM	52224-69A	52224-69B
5MM Ø, BIOPSY SPOON FORCEPS, DOUBLE-ACTION	33 CM	52255-70A	52255-70B
	36 CM	52236-70A	52236-70B
	45 CM	52155-70A	52155-70B
	24 CM	52224-70A	52224-70B
5MM Ø, BIOPSY SPOON FORCEPS, W/ TOOTH (SEMM-TYPE), DBL-ACTION	33 CM	52255-68A	52255-68B
	36 CM	52236-68A	52236-68B
	45 CM	52155-68A	52155-68B
	24 CM	52224-68A	52224-68B
5MM Ø, BIOPSY HOOK PUNCH, SINGLE-ACTION	33 CM	52255-71A	52255-71B
	36 CM	52236-71A	52236-71B
	45 CM	52155-71A	52155-71B
	24 CM	52224-71A	52224-71B
5MM Ø, BIOPSY PUNCH WITH TOOTH, SINGLE-ACTION	33 CM	52255-72A	52255-72B
	36 CM	52236-72A	52236-72B
	45 CM	52155-72A	52155-72B
	24 CM	52224-72A	52224-72B
5MM Ø, BIOPSY PUNCH, SINGLE-ACTION	33 CM	52255-73A	52255-73B
	36 CM	52236-73A	52236-73B
	45 CM	52155-73A	52155-73B
	24 CM	52224-73A	52224-73B

Recommended

Optional



Type 1:  
Insulated Stainless Steel w/ RF Post



Type 3:  
Non-Insulated Stainless Steel

OR



Type 5:  
Lightweight Carbon-Fiber w/ RF Post



Type 7:  
Lightweight Carbon-Fiber w/ RF Post, Ratchet / Ratchet Defeating

OR



Type 17:  
Lightweight Carbon-Fiber w/ RF Post



Type 9:  
Lightweight Carbon-Fiber w/ RF Post, w/ Large Finger Loops



Type 18:  
Carbon-Fiber w/ RF Post, Ratchet / Ratchet Defeating

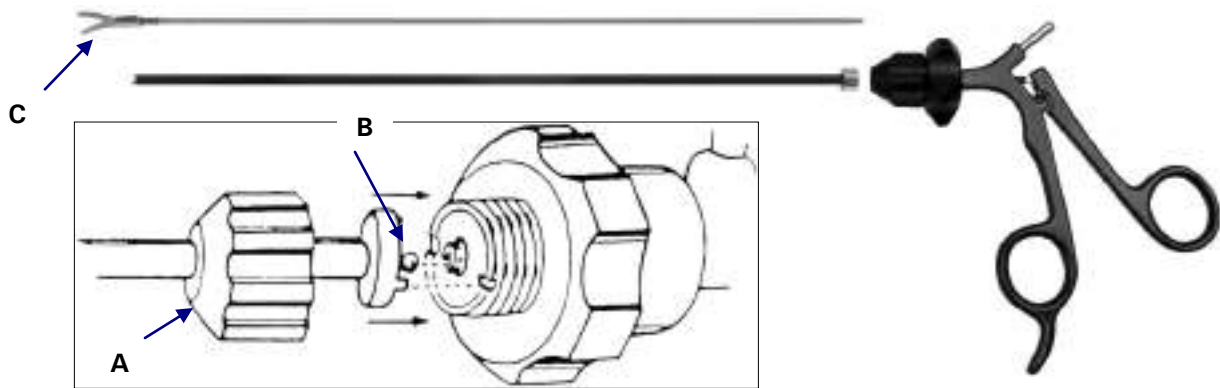

**ASSEMBLY:**

1. Turn the **Tip (C)** clockwise into the shaft
2. Set the handle in the open position & engage the **Ball (B)** of **Inner Rod** into its fixation in the handle port.
3. Turn main **Screw Cap (A)** clockwise until it engages the handle.

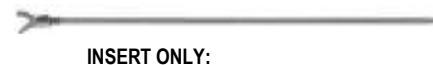

	<u>Length</u>	<u>Style C:</u>	<u>Insert Only:</u>
5MM Ø, MICRO REDDICK-OLSEN GRASPER/DISSECTOR	33 CM	52255-01C	52255-01I
	36 CM	52236-01C	52236-01I
	45 CM	52155-01C	52155-01I
	24 CM	52224-01C	52224-01I
5MM Ø, STANDARD GRASPER/DISSECTOR WITH SPOON	33 CM	52255-02C	52255-02I
	36 CM	52236-02C	52236-02I
	45 CM	52155-02C	52155-02I
	24 CM	52224-02C	52224-02I
5MM Ø, STANDARD GRASPER/DISSECTOR W/ SPOON, LONG 20 MM JAW	52255-01A	52255-52C	52255-52I
	52236-01A	52236-52C	52236-52I
	52155-01A	52155-52C	52155-52I
	52224-01A	52224-52C	52224-52I
5MM Ø, STANDARD GRASPER/DISSECTOR	33 CM	52255-03C	52255-03I
	36 CM	52236-03C	52236-03I
	45 CM	52155-03C	52155-03I
	24 CM	52224-03C	52224-03I
5MM Ø, BULLET-NOSE GRASPER/DISSECTOR WITH SPOON	33 CM	52255-04C	52255-04I
	36 CM	52236-04C	52236-04I
	45 CM	52155-04C	52155-04I
	24 CM	52224-04C	52224-04I
5MM Ø, TAPERED DOLPHIN-NOSE GRASPER/DISSECTOR	33 CM	52255-05C	52255-05I
	36 CM	52236-05C	52236-05I
	45 CM	52155-05C	52155-05I
	24 CM	52224-05C	52224-05I
5MM Ø, TAPERED DOLPHIN-NOSE GRASPER/DISSECTOR W/ SPOON	33 CM	52255-105C	52255-105I
	36 CM	52236-105C	52236-105I
	45 CM	52155-105C	52155-105I
	24 CM	52224-105C	52224-105I
5MM Ø, MARYLAND GRASPER/DISSECTOR, 18MM LENGTH TIP	33 CM	52255-06A	52255-06B
	36 CM	5223606A	52236-06B
	45 CM	52155-06A	52155-06B
	24 CM	52224-06A	52224-06B
5MM Ø, TAPERED MARYLAND GRASPER/DISSECTOR, 18MM LENGTH TIP	33 CM	52255-99C	52255-99I
	36 CM	52236-99C	52236-99I
	45 CM	52155-99C	52155-99I
	24 CM	52224-99C	52224-99I
5MM Ø, SHORT MARYLAND GRASPER/DISSECTOR, 15MM LENGTH TIP	33 CM	52255-91C	52255-91I
	36 CM	52236-91C	52236-91I
	45 CM	52155-91C	52155-91I
	24 CM	52224-91C	52224-91I

Recommended

Optional

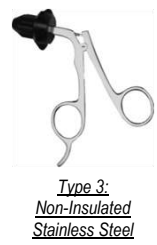

Type 1:  
Insulated Stainless Steel w/ RF Post

Type 3:  
Non-Insulated Stainless Steel

OR



Type 5:  
Lightweight Carbon-Fiber w/ RF Post

Type 7:  
Lightweight Carbon-Fiber w/ RF Post, Ratchet / Ratchet Defeating

OR



Type 17:  
Lightweight Carbon-Fiber w/ RF Post

Type 9:  
Lightweight Carbon-Fiber w/ RF Post, w/ Large Finger Loops



Type 18:  
Carbon-Fiber w/ RF Post, Ratchet / Ratchet Defeating

We offer complete solution for Electrosurgical Accessories for hospital at the right price.

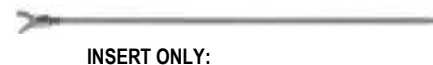

	<u>Length</u>	<u>Style C:</u>	<u>Insert Only:</u>
5MM Ø, MIXTER GRASPER/ DISSECTOR RIGHT ANGLE (LONG)	33 CM	52255-07C	52255-07I
	36 CM	52236-07C	52236-07I
	45 CM	52155-07C	52155-07I
	24 CM	52224-07C	52224-07I
5MM Ø, MIXTER GRASPER/ DISSECTOR, SHORT RIGHT ANGLE	33 CM	52255-59C	52255-59I
	36 CM	52236-59C	52236-59I
	45 CM	52155-59C	52155-59I
	24 CM	52224-59C	52224-59I
5MM Ø, MIXTER GRASPER/ DISSECTOR 45 DEGREE ANGLE	33 CM	52255-08C	52255-08I
	36 CM	52236-08C	52236-08I
	45 CM	52155-08C	52155-08I
	24 CM	52224-08C	52224-08I
5MM Ø, DUCKBILL GRASPER/ DISSECTOR	33 CM	52255-09C	52255-09I
	36 CM	52236-09C	52236-09I
	45 CM	52155-09C	52155-09I
	24 CM	52224-09C	52224-09I
5MM Ø, NEEDLE-NOSE GRASPER/DISSECTOR	33 CM	52255-10C	52255-10I
	36 CM	52236-10C	52236-10I
	45 CM	52155-10C	52155-10I
	24 CM	52224-10C	52224-10I
5MM Ø, KELLY GRASPER/ DISSECTOR	33 CM	52255-11C	52255-11I
	36 CM	52236-11C	52236-11I
	45 CM	52155-11C	52155-11I
	24 CM	52224-11C	52224-11I
5MM Ø, LONG REACH, RIGHT ANGLE DISSECTOR, DBL- ACTION (REQUIRES LARGER CANNULA)	33 CM	52255-53C	52255-53I
	36 CM	52236-53C	52236-53I
	45 CM	52155-53C	52155-53I
	24 CM	52224-53C	52224-53I
5MM Ø, PETELIN DISSECTOR, 60 DEG. ANGLE LEFT, SINGLE-ACTION	33 CM	52255-12C	52255-12I
	36 CM	52236-12C	52236-12I
	45 CM	52155-12C	52155-12I
	24 CM	52224-12C	52224-12I
5MM Ø, PETELIN DISSECTOR, 30 DEG. ANGLE LEFT, SINGLE- ACTION	33 CM	52255-13C	52255-13I
	36 CM	52236-13C	52236-13I
	45 CM	52155-13C	52155-13I
	24 CM	52224-13C	52224-13I
5MM Ø, MICRO GRASPER/ DISSECTOR, FENESTRATED	33 CM	52255-14C	52255-14I
	36 CM	52236-14C	52236-14I
	45 CM	52155-14C	52155-14I
	24 CM	52224-14C	52224-14I

<u>Recommended</u>	<u>Optional</u>
	
Type 1: <u>Insulated Stainless Steel w/ RF Post</u>	Type 3: <u>Non-Insulated Stainless Steel</u>
<b>OR</b>	
	Type 7: <u>Lightweight Carbon-Fiber w/ RF Post, Ratchet / Ratchet Defeating</u>
Type 5: <u>Lightweight Carbon-Fiber w/ RF Post</u>	
<b>OR</b>	Type 9: <u>Lightweight Carbon-Fiber w/ RF Post, w/ Large Finger Loops</u>
	
Type 17: <u>Lightweight Carbon-Fiber w/ RF Post</u>	Type 18: <u>Carbon-Fiber w/ RF Post, Ratchet / Ratchet Defeating</u>

We offer complete solution for Electrosurgical Accessories for hospital at the right price.





**STYLE C:**  
MODULAR 3-PIECE TAKE APART



**INSERT ONLY:**



	<u>Length</u>	<u>Style C:</u>	<u>Insert Only:</u>
5MM Ø, COBRA GRASPER, DOUBLE-ACTION	33 CM	52255-15C	52255-15I
	36 CM	52236-15C	52236-15I
	45 CM	52155-15C	52155-15I
	24 CM	52224-15C	52224-15I
5MM Ø, BABCOCK GRASPER, FENESTRATED TIP	33 CM	52255-16C	52255-16I
	36 CM	52236-16C	52236-16I
	45 CM	52155-16C	52155-16I
	24 CM	52224-16C	52224-16I
5MM Ø, BABCOCK GRASPER, AXIS STYLE, FENESTRATED TIP	33 CM	52255-116C	52255-116I
	36 CM	52236-116C	52236-116I
	45 CM	52155-116C	52155-116I
	24 CM	52224-116C	52224-116I
5MM Ø, BABCOCK GRASPER-SHORT: DELICATE APPLICATION	33 CM	52255-17C	52255-17I
	36 CM	52236-17C	52236-17I
	45 CM	52155-17C	52155-17I
	24 CM	52224-17C	52224-17I
5MM Ø, ALLIS GRASPER, SHORT VERSION, SINGLE ACTION	33 CM	52255-18C	52255-18I
	36 CM	52236-18C	52236-18I
	45 CM	52155-18C	52155-18I
	24 CM	52224-18C	52224-18I
5MM Ø, ALLIS GRASPER, SHORT VERSION, 3 X 4 TEETH, SERRATED, DOUBLE-ACTION	33 CM	52255-19C	52255-19I
	36 CM	52236-19C	52236-19I
	45 CM	52155-19C	52155-19I
	24 CM	52224-19C	52224-19I
5MM Ø, ATRAUMATIC ALLIS GRASPER, SHORT VERSION, SERRATED W/ DOUBLE ROW OF TEETH, DOUBLE-ACTION	33 CM	52255-119C	52255-119I
	36 CM	52236-119C	52236-119I
	45 CM	52155-119C	52155-119I
	24 CM	52224-119C	52224-119I
5MM Ø, ATRAUMATIC ALLIS GRASPER, LONG VERSION, SERRATED W/ DOUBLE ROW OF TEETH, DOUBLE-ACTION	33 CM	52255-219A	52255-219B
	36 CM	52236-219A	52236-219B
	45 CM	52155-219A	52155-219B
	24 CM	52224-219A	52224-219B
5MM Ø, ALLIS GRASPER, MEDIUM VERSION, (WECK STYLE)	33 CM	52255-20C	52255-20I
	36 CM	52236-20C	52236-20I
	45 CM	52155-20C	52155-20I
	24 CM	52224-20C	52224-20I
5MM Ø, ALLIS GRASPER, STANDARD VERSION	33 CM	52255-21C	52255-21I
	36 CM	52236-21C	52236-21I
	45 CM	52155-21C	52155-21I
	24 CM	52224-21C	52224-21I

**Recommended**



Type 2:  
Insulated Stainless Steel w/ RF Post & Ratchet

**OR**



Type 6:  
Lightweight Carbon-Fiber w/ RF Post & Ratchet

**OR**



Type 9:  
Lightweight Carbon-Fiber w/ RF Post, Ratchet / Ratchet Defeating w/ Large Finger Loops

**Optional**



Type 4:  
Non-Insulated Stainless Steel w/ Ratchet



Type 7:  
Lightweight Carbon-Fiber w/ RF Post, Ratchet / Ratchet Defeating



Type 8:  
Lightweight Carbon-Fiber w/ RF Post, French On/Off Ratchet



Type 18:  
Carbon-Fiber w/ RF Post, Ratchet / Ratchet Defeating

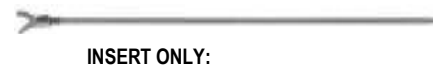

	<u>Length</u>	<u>Style C:</u>	<u>Insert Only:</u>
5MM Ø, TC ALLIS, STANDARD VERSION	33 CM	52255-57C	52255-57I
	36 CM	52236-57C	52236-57I
	45 CM	52155-57C	52155-57I
	24 CM	52224-57C	52224-57I
5MM Ø, DEBAKEY GRASPER, 20 MM JAW LENGTH	33 CM	52255-22cC	52255-22I
	36 CM	52236-22C	52236-22I
	45 CM	52155-22C	52155-22I
	24 CM	52224-22C	52224-22I
5MM Ø, DEBAKEY GRASPER, 40 MM JAW LENGTH	33 CM	52255-23C	52255-23I
	36 CM	52236-23C	52236-23I
	45 CM	52155-23C	52155-23I
	24 CM	52224-23C	52224-23I
5MM Ø, HUNTER/ FENESTRATED DEBAKEY GRASPER, 20 MM JAW LENGTH	33 CM	52255-58C	52255-58I
	36 CM	52236-58C	52236-58I
	45 CM	52155-58C	52155-58I
	24 CM	52224-58C	52224-58I
5MM Ø, HUNTER/ FENESTRATED DEBAKEY GRASPER, 40 MM JAW LENGTH	33 CM	52255-159C	52255-159I
	36 CM	52236-159C	52236-159I
	45 CM	52155-159C	52155-159I
	24 CM	52224-159C	52224-159I
5MM Ø, HUNTER/ FENESTRATED DEBAKEY GRASPER, 60 MM JAW LENGTH	33 CM	52255-160C	52255-160I
	36 CM	52236-160C	52236-160I
	45 CM	52155-160C	52155-160I
	24 CM	52224-160C	52224-160I
5MM Ø, DEBAKEY CURVED GRASPER, w/ ATRAUMATIC TEETH, DOUBLE-ACTION	33 CM	52255-46C	52255-46I
	36 CM	52236-46C	52236-46I
	45 CM	52155-46C	52155-46I
	24 CM	52224-46C	52224-46I
5MM Ø, GLASSMAN ATRAUMATIC GRASPER	33 CM	52255-24C	52255-24I
	36 CM	52236-24C	52236-24I
	45 CM	52155-24C	52155-24I
	24 CM	52224-24C	52224-24I
5MM Ø, ATRAUMATIC GRASPER, CROSS SERRATED	33 CM	52255-25C	52255-25I
	36 CM	52236-25C	52236-25I
	45 CM	52155-25C	52155-25I
	24 CM	52224-25C	52224-25I
5MM Ø, DOUBLE CUP FUNDUS MAXI GRASPER	33 CM	52255-26C	52255-26I
	36 CM	52236-26C	52236-26I
	45 CM	52155-26C	52155-26I
	24 CM	52224-26C	52224-26I



OR







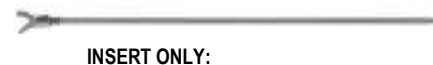

OR



We offer complete solution for Electrosurgical Accessories for hospital at the right price.



	<u>Length</u>	<u>Style C:</u>	<u>Insert Only:</u>
5MM Ø, "WINER" STYLE FUNDUS MAXI GRASPER	33 CM	52255-326C	52255-326I
	36 CM	52236-326C	52236-326I
	45 CM	52155-326C	52155-326I
	24 CM	52224-326C	52224-326I
5MM Ø, "MCKERNAN" STYLE FUNDUS MAXI GRASPER	33 CM	52255-126C	52255-126I
	36 CM	52236-126C	52236-126I
	45 CM	52155-126C	52155-126I
	24 CM	52224-126C	52224-126I
5MM Ø, DOUBLE CUP FENESTRATED FUNDUS MAXI GRASPER	33 CM	52255-226C	52255-226I
	36 CM	52236-226C	52236-226I
	45 CM	52155-226C	52155-226I
	24 CM	52224-226C	52224-226I
5MM Ø, ENDO CLINCH FENESTRATED GRASPER	33 CM	52255-27C	52255-27I
	36 CM	52236-27C	52236-27I
	45 CM	52155-27C	52155-27I
	24 CM	52224-27C	52224-27I
5MM Ø, RETRO FACING RAT-TOOTH GRASPER w/ ATRAUMATIC CUP	33 CM	52255-28C	52255-28I
	36 CM	52236-28C	52236-28I
	45 CM	52155-28C	52155-28I
	24 CM	52224-28C	52224-28I
5MM Ø, ALLIGATOR GRASPER, 10MM JAW, RETRO FACING TEETH, DBL-ACTION	33 CM	52255-29C	52255-29I
	36 CM	52236-29C	52236-29I
	45 CM	52155-29C	52155-29I
	24 CM	52224-29C	52224-29I
5MM Ø, ALLIGATOR GRASPER, 20MM JAW, RETRO FACING TEETH, DBL-ACTION	33 CM	52255-129C	52255-129I
	36 CM	52236-129C	52236-129I
	45 CM	52155-129C	52155-129I
	24 CM	52224-129C	52224-129I
5MM Ø, ALLIGATOR GRASPER, RETRO FACING TEETH, SINGLE-ACTION	33 CM	52255-30C	52255-30I
	36 CM	52236-30C	52236-30I
	45 CM	52155-30C	52155-30I
	24 CM	52224-30C	52224-30I
5MM Ø, CUP SHAPED GRASPER WITH RETRO FACING TEETH, DBL-ACTION	33 CM	52255-58C	52255-58I
	36 CM	52236-58C	52236-58I
	45 CM	52155-58C	52155-58I
	24 CM	52224-58C	52224-58I
5MM Ø, WAVE GRASPER, LONG BEVELED EDGE JAW, DBL-ACTION	33 CM	52255-32C	52255-32I
	36 CM	52236-32C	52236-32I
	45 CM	52155-32C	52155-32I
	24 CM	52224-32C	52224-32I

<u>Recommended</u>	<u>Optional</u>
	
Type 2: <i>Insulated Stainless Steel w/ RF Post &amp; Ratchet</i>	Type 4: <i>Non-Insulated Stainless Steel w/ Ratchet</i>
<b>OR</b>	
	Type 7: <i>Lightweight Carbon-Fiber w/ RF Post, Ratchet / Ratchet Defeating</i>
Type 6: <i>Lightweight Carbon-Fiber w/ RF Post &amp; Ratchet</i>	<b>OR</b>
<b>OR</b>	
	Type 8: <i>Lightweight Carbon-Fiber w/ RF Post, French On/Off Ratchet</i>
Type 9: <i>Lightweight Carbon-Fiber w/ RF Post, Ratchet / Ratchet Defeating w/ Large Finger Loops</i>	
	Type 18: <i>Carbon-Fiber w/ RF Post, Ratchet / Ratchet Defeating</i>

*We offer complete solution for Electrosurgical Accessories for hospital at the right price.*

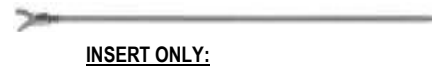
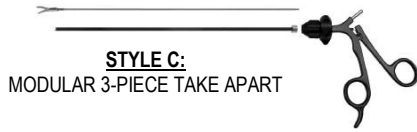

	<u>Length</u>	<u>Style C:</u>	<u>Insert Only:</u>
5MM Ø, WAVE GRASPER, LONG BEVELED EDGE JAW, SINGLE ACTION	33 CM	52255-33C	52255-33I
	36 CM	52236-33C	52236-33I
	45 CM	52155-33C	52155-33I
	24 CM	52224-33C	52224-33I
5MM Ø, CLAW GRASPER, 2 X 3 TEETH, SINGLE-ACTION	33 CM	52255-36C	52255-36I
	36 CM	52236-36C	52236-36I
	45 CM	52155-36C	52155-36I
	24 CM	52224-36C	52224-36I
5MM Ø, CLAW GRASPER, 2 X 3 TEETH, W/ EXTRA ROW OF TEETH, DOUBLE-ACTION	33 CM	52255-136C	52255-136I
	36 CM	52236-136C	52236-136I
	45 CM	52155-136C	52155-136I
	24 CM	52224-136C	52224-136I
5MM Ø, RETRACTION GRASPER, LONG RIDGED JAWS, 2 X 3 ATRAUMATIC TEETH, DOUBLE-ACTION	33 CM	52255-34C	52255-34I
	36 CM	52236-34C	52236-34I
	45 CM	52155-34C	52155-34I
	24 CM	52224-34C	52224-34I
5MM Ø, RETRACTION GRASPER, LONG RIDGED JAWS, 2 X 3 ATRAUMATIC TEETH, SINGLE-ACTION	33 CM	52255-35C	52255-35I
	36 CM	52236-35C	52236-35I
	45 CM	52155-35C	52155-35I
	24 CM	52224-35C	52224-35I
5MM Ø, RETRACTION GRASPER, 2 X 3 ATRAUMATIC TEETH, DOUBLE-ACTION (JARIT STYLE)	33 CM	52255-134C	52255-134I
	36 CM	52236-134C	52236-134I
	45 CM	52155-134C	52155-134I
	24 CM	52224-134C	52224-134I
5MM Ø, RETRACTION GRASPER, 2 X 3 ATRAUMATIC TEETH, SINGLE-ACTION (JARIT STYLE)	33 CM	52255-135C	52255-135I
	36 CM	52236-135C	52236-135I
	45 CM	52155-135C	52155-135I
	24 CM	52224-135C	52224-135I
5MM Ø, ATRAUMATIC FENESTRATED GRASPER, CURVED, 16 MM DBL-ACTION JAW	33 CM	52255-37C	52255-37I
	36 CM	52236-37C	52236-37I
	45 CM	52155-37C	52155-37I
	24 CM	52224-37C	52224-37I
5MM Ø, FENESTRATED GRASPER, 16 MM DBL-ACTION JAW	33 CM	52255-38C	52255-38I
	36 CM	52236-38C	52236-38I
	45 CM	52155-38C	52155-38I
	24 CM	52224-38C	52224-38I
5MM Ø, FENESTRATED GRASPER, 20 MM DBL-ACTION JAW	33 CM	52255-39C	52255-39I
	36 CM	52236-39C	52236-39I
	45 CM	52155-39C	52155-39I
	24 CM	52224-39C	52224-39I



We offer complete solution for Electrosurgical Accessories for hospital at the right price.

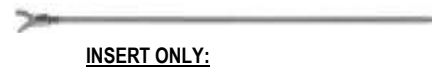
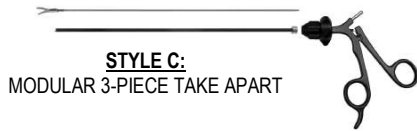

	<u>Length</u>	<u>Style C:</u>	<u>Insert Only:</u>
5MM Ø, FENESTRATED GRASPER, 40 MM DBL-ACTION JAW	33 CM	52255-40C	52255-40I
	36 CM	52236-40C	52236-40I
	45 CM	52155-40C	52155-40I
	24 CM	52224-40C	52224-40I
5MM Ø, JOHAN FENESTRATED GRASPER, 22 MM SINGLE-ACTION FLAT JAWS	33 CM	52255-41C	52255-41I
	36 CM	52236-41C	52236-41I
	45 CM	52155-41C	52155-41I
	24 CM	52224-41C	52224-41I
5MM Ø, JOHAN FENESTRATED GRASPER, 45 MM SGL-ACTION FLAT JAWS	33 CM	52255-42C	52255-42I
	36 CM	52236-42C	52236-42I
	45 CM	52155-42C	52155-42I
	24 CM	52224-42C	52224-42I
5MM Ø, KOCHER GRASPER, 1 X 2 TEETH, SINGLE-ACTION FLAT JAWS	33 CM	52255-43C	52255-43I
	36 CM	52236-43C	52236-43I
	45 CM	52155-43C	52155-43I
	24 CM	52224-43C	52224-43I
5MM Ø, KOCHER GRASPER, 1 X 2 TEETH, DOUBLE-ACTION (WECK TYPE)	33 CM	52255-44C	52255-44I
	36 CM	52236-44C	52236-44I
	45 CM	52155-44C	52155-44I
	24 CM	52224-44C	52224-44I
5MM Ø, SCHROEDER TENACULUM GRASPER, SINGLE TEETH	33 CM	52255-45C	52255-45I
	36 CM	52236-45C	52236-45I
	45 CM	52155-45C	52155-45I
	24 CM	52224-45C	52224-45I
5MM Ø, SCHROEDER TENACULUM GRASPER, SINGLE TEETH w/ EXTRA GUIDE TOOTH	33 CM	52255-94C	52255-94I
	36 CM	52236-94C	52236-94I
	45 CM	52155-94C	52155-94I
	24 CM	52224-94C	52224-94I
5MM Ø, BLUNT ATRAUMATIC GRASPING FORCEPS, DOUBLE-ACTION	33 CM	52255-47C	52255-47I
	36 CM	52236-47C	52236-47I
	45 CM	52155-47C	52155-47I
	24 CM	52224-47C	52224-47I
5MM Ø, BLUNT ATRAUMATIC GRASPER W/ CROSS-SERRATED TIPS, DBL-ACTION	33 CM	52255-56C	52255-56I
	36 CM	52236-56C	52236-56I
	45 CM	52155-56C	52155-56I
	24 CM	52224-56C	52224-56I
5MM Ø, BULLET NOSE GRASPER/DISSECTOR, TC, MICRO DIAMOND JAW PATTERN DOUBLE-ACTION	33 CM	52255-48C	52255-48I
	36 CM	52236-48C	52236-48I
	45 CM	52155-48C	52155-48I
	24 CM	52224-48C	52224-48I

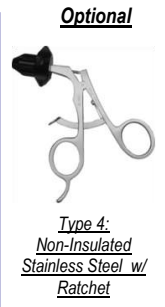



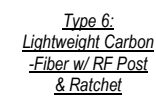





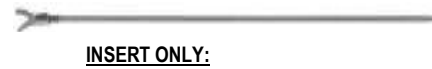







**OR**



**OR**





	<u>Length</u>	<u>Style C:</u>	<u>Insert Only:</u>	<u>Recommended</u>	<u>Optional</u>
	5MM Ø, BULLET NOSE GRASPER/DISSECTOR, TC, CROSS DIAMOND JAW PATTERN DOUBLE-ACTION	33 CM	52255-49C	52255-49I	 Type 4: Non-Insulated Stainless Steel w/ Ratchet
		36 CM	52236-49C	52236-49I	
		45 CM	52155-49C	52155-49I	
		24 CM	52224-49C	52224-49I	
	5MM Ø, LONG TAPERED GRASPER W/ ATRAUMATIC TEETH, DBL-ACTION	33 CM	52255-51C	52255-51I	 Type 2: Insulated Stainless Steel w/ RF Post & Ratchet
		36 CM	52236-51C	52236-51I	
		45 CM	52155-51C	52155-51I	
		24 CM	52224-51C	52224-51I	
	5MM Ø, WAVE GRASPER, POINTED, SINGLE-ACTION	33 CM	52255-54C	52255-54I	OR  Type 7: Lightweight Carbon-Fiber w/ RF Post, Ratchet / Ratchet Defeating
		36 CM	52236-54C	52236-54I	
		45 CM	52155-54C	52155-54I	
		24 CM	52224-54C	52224-54I	
	5MM Ø, WAVE GRASPER, BLUNT, SINGLE-ACTION	33 CM	52255-55C	52255-55I	 Type 6: Lightweight Carbon -Fiber w/ RF Post & Ratchet
		36 CM	52236-55C	52236-55I	
		45 CM	52155-55C	52155-55I	
		24 CM	52224-55C	52224-55I	
	5MM Ø, "DAVOL" TYPE, ATRAUMATIC GRASPER, SCOOPED-OUT JAW & GENTLY MASHING TEETH	33 CM	52255-90C	52255-90I	 Type 8: Lightweight Carbon-Fiber w/ RF Post, French On/Off Ratchet
		36 CM	52236-90C	52236-90I	
		45 CM	52155-90C	52155-90I	
		24 CM	52224-90C	52224-90I	
	5MM Ø, "ACCESS" TYPE, FENESTRATED GRASPER, 20MM JAW W/ AGGRESSIVE TEETH FOR POSITIVE EXTRA STRONG TISSUE HOLDING	33 CM	52255-91C	52255-91I	 Type 9: Lightweight Carbon-Fiber w/ RF Post, Ratchet / Ratchet Defeating w/ Large Finger Loops
		36 CM	52236-91C	52236-91I	
		45 CM	52155-91C	52155-91I	
		24 CM	52224-91C	52224-91I	
	5MM Ø, "SOFT TOUCH" GRASPER, 22 MM JAW, ATRAUMATIC TEFLON INSERTS FOR THE LIGHT MINIMUM TISSUE TRAUMA TOUCH YET POSITIVE HOLDING	33 CM	52255-144C	52255-144I	 Type 18: Carbon-Fiber w/ RF Post, Ratchet / Ratchet Defeating
		36 CM	52236-144C	52236-144I	
		45 CM	52155-144C	52155-144I	
		24 CM	52224-144C	52224-144I	
	5MM Ø, "SOFT TOUCH" GRASPER, 40 MM JAW, ATRAUMATIC TEFLON INSERTS FOR THE LIGHT MINIMUM TISSUE TRAUMA TOUCH YET POSITIVE HOLDING	33 CM	52255-145C	52255-145I	
		36 CM	52236-145C	52236-145I	
		45 CM	52155-145C	52155-145I	
		24 CM	52224-145C	52224-145I	



	<u>Length</u>	<u>Style C:</u>	<u>Insert Only:</u>
5MM Ø, HOOK SCISSORS, SINGLE-ACTION	33 CM	52255-60C	52255-60I
	36 CM	52236-60C	52236-60I
	45 CM	52155-60C	52155-60I
	24 CM	52224-60C	52224-60I
5MM Ø, MICRO TIP SCISSORS, STRAIGHT, SINGLE-ACTION	33 CM	52255-61C	52255-61I
	36 CM	52236-61C	52236-61I
	45 CM	52155-61C	52155-61I
	24 CM	52224-61C	52224-61I
5MM Ø, MICRO TIP SCISSORS, CURVED, SINGLE-ACTION	33 CM	52255-62C	52255-62I
	36 CM	52236-62C	52236-62I
	45 CM	52155-62C	52155-62I
	24 CM	52224-62C	52224-62I
5MM Ø, METZENBAUM SCISSORS, STRAIGHT, LONG BLADE (20MM TIP)	33 CM	52255-63C	52255-63I
	36 CM	52236-63C	52236-63I
	45 CM	52155-63C	52155-63I
	24 CM	52224-63C	52224-62I
5MM Ø, METZENBAUM SCISSORS, STRAIGHT, SHORT BLADE (12MM TIP)	33 CM	52255-64C	52255-64I
	36 CM	52236-64C	52236-64I
	45 CM	52155-64C	52155-64I
	24 CM	52224-64C	52224-64I
5MM Ø, METZENBAUM SCISSORS, CURVED, LONG BLADE (18MM TIP)	33 CM	52255-65C	52255-65I
	36 CM	52236-65C	52236-65I
	45 CM	52155-65C	52155-65I
	24 CM	52224-65C	52224-65I
5MM Ø, METZENBAUM SCISSORS, HARDENED STEEL, CURVED BLADE (16MM TIP)	33 CM	52255-66C	52255-66I
	36 CM	52236-66C	52236-66I
	45 CM	52155-66C	52155-66I
	24 CM	52224-66C	52224-66I
5MM Ø, METZENBAUM SCISSORS, CURVED, SHORT BLADE (11MM TIP)	33 CM	52255-166C	52255-166I
	36 CM	52236-166C	52236-166I
	45 CM	52155-166C	52155-166I
	24 CM	52224-166C	52224-166I
5MM Ø, PERITONEAL SCISSORS, SINGLE-ACTION	33 CM	52255-67C	52255-67I
	36 CM	52236-67C	52236-67I
	45 CM	52155-67C	52155-67I
	24 CM	52224-67C	52224-67I
5MM Ø, HOOK SCISSORS, TS, EXTRA HARD STEEL	33 CM	52255-76C	52255-76I
	36 CM	52236-76C	52236-76I
	45 CM	52155-76C	52155-76I
	24 CM	52224-76C	52224-76I

<u>Recommended</u>	<u>Optional</u>
	
Type 1: <i>Insulated Stainless Steel w/ RF Post</i>	Type 3: <i>Non-Insulated Stainless Steel</i>
<b>OR</b>	
	Type 7: <i>Lightweight Carbon-Fiber w/ RF Post, Ratchet / Ratchet Defeating</i>
Type 5: <i>Lightweight Carbon-Fiber w/ RF Post</i>	
<b>OR</b>	Type 9: <i>Lightweight Carbon-Fiber w/ RF Post, w/ Large Finger Loops</i>
	
Type 17: <i>Lightweight Carbon-Fiber w/ RF Post</i>	Type 18: <i>Carbon-Fiber w/ RF Post, Ratchet / Ratchet Defeating</i>

We offer complete solution for Electrosurgical Accessories for hospital at the right price.



	<u>Length</u>	<u>Style C:</u>	<u>Insert Only:</u>
5MM Ø, PERITONEAL SCISSORS, TS, EXTRA HARD STEEL, SINGLE-ACTION	33 CM	52255-77C	52255-77I
	36 CM	52236-77C	52236-77I
	45 CM	52155-77C	52155-77I
	24 CM	52224-77C	52224-77I
5MM Ø, PERITONEAL SCISSORS, TS, EXTRA HARD STEEL, DOUBLE-ACTION	33 CM	52255-78C	52255-78I
	36 CM	52236-78C	52236-78I
	45 CM	52155-78C	52155-78I
	24 CM	52224-78C	52224-78I
5MM Ø, BIOPSY SPOON FORCEPS W/ TOOTH, (SEMM-TYPE) SINGLE-ACTION	33 CM	52255-79C	52255-79I
	36 CM	52236-79C	52236-79I
	45 CM	52155-79C	52155-79I
	24 CM	52224-79C	52224-79I
5MM Ø, BIOPSY SPOON FORCEPS, SINGLE-ACTION	33 CM	52255-69C	52255-69I
	36 CM	52236-69C	52236-69I
	45 CM	52155-69C	52155-69I
	24 CM	52224-69C	52224-69I
5MM Ø, BIOPSY SPOON FORCEPS, DOUBLE-ACTION	33 CM	52255-70C	52255-70I
	36 CM	52236-70C	52236-70I
	45 CM	52155-70C	52155-70I
	24 CM	52224-70C	52224-70I
5MM Ø, BIOPSY SPOON FORCEPS, W/ TOOTH (SEMM-TYPE), DBL-ACTION	33 CM	52255-68C	52255-68I
	36 CM	52236-68C	52236-68I
	45 CM	52155-68C	52155-68I
	24 CM	52224-68C	52224-68I
5MM Ø, BIOPSY HOOK PUNCH, SINGLE-ACTION	33 CM	52255-71C	52255-71I
	36 CM	52236-71C	52236-71I
	45 CM	52155-71C	52155-71I
	24 CM	52224-71C	52224-71I
5MM Ø, BIOPSY PUNCH WITH TOOTH, SINGLE-ACTION	33 CM	52255-72C	52255-72I
	36 CM	52236-72C	52236-72I
	45 CM	52155-72C	52155-72I
	24 CM	52224-72C	52224-72I
5MM Ø, BIOPSY PUNCH, SINGLE-ACTION	33 CM	52255-73C	52255-73I
	36 CM	52236-73C	52236-73I
	45 CM	52155-73C	52155-73I
	24 CM	52224-73C	52224-73I

**Recommended**



Type 1:  
Insulated Stainless Steel w/ RF Post

**OR**



Type 7:  
Lightweight Carbon-Fiber w/ RF Post, Ratchet / Ratchet Defeating

**OR**



Type 5:  
Lightweight Carbon-Fiber w/ RF Post

**OR**



Type 17:  
Lightweight Carbon-Fiber w/ RF Post

**Optional**



Type 3:  
Non-Insulated Stainless Steel



Type 9:  
Lightweight Carbon-Fiber w/ RF Post, Ratchet / Ratchet Defeating



Type 18:  
Carbon-Fiber w/ RF Post, Ratchet / Ratchet Defeating

We offer complete solution for Electrosurgical Accessories for hospital at the right price.



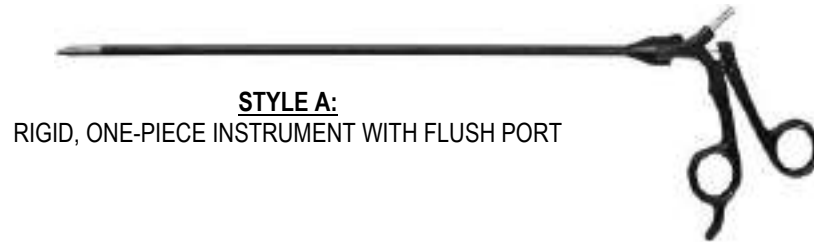



**STYLE A:**  
RIGID, ONE-PIECE INSTRUMENT  
WITH FLUSH PORT



**STYLE B:**  
ROTATABLE, ONE-PIECE INSTRUMENT  
WITH FLUSH PORT



	<u>Length</u>	<u>Style A:</u>	<u>Style B:</u>
10MM, STRONG GRASPER/ DISSECTOR	33 CM	52102-02A	52102-02B
	36 CM	52103-02A	52103-02B
	45 CM	52101-02A	52101-02B
10MM, MARYLAND GRASPER/ DISSECTOR	33 CM	52102-06A	52102-06B
	36 CM	52103-06A	52103-06B
	45 CM	52101-06A	52101-06B
10MM, MIXTER GRASPER/ DISSECTOR, RIGHT ANGLE	33 CM	52102-07A	52102-07B
	36 CM	52103-07A	52103-07B
	45 CM	52101-07A	52101-07B
10MM, MIXTER GRASPER/ DISSECTOR, SHORT RIGHT ANGLE	33 CM	52102-59A	52102-59B
	36 CM	52103-59A	52103-59B
	45 CM	52101-59A	52101-59B
10MM, MIXTER GRASPER/ DISSECTOR, 45° ANGLE	33 CM	52102-08A	52102-08B
	36 CM	52103-08A	52103-08B
	45 CM	52101-08A	52101-08B
10MM, BABCOCK GRASPER, FENESTRATED TIP	33 CM	52102-16A	52102-16B
	36 CM	52103-16A	52103-16B
	45 CM	52101-16A	52101-16B
US BABCOCK GRASPER, SPRING TENSION, ATRAUMATIC	33 CM	52102-17A	52102-17B
	36 CM	52103-17A	52103-17B
	45 CM	52101-17A	52101-17B
10MM, ALLIS GRASPER, FINE AXIAL SERRATIONS	33 CM	52102-21A	52102-21B
	36 CM	52103-21A	52103-21B
	45 CM	52101-21A	52101-21B
10MM, DEBAKEY GRASPER, 40 MM JAW	33 CM	52102-22A	52102-22B
	36 CM	52103-22A	52103-22B
	45 CM	52101-22A	52101-22B
10MM, DEBAKEY GRASPER, 60 MM JAW	33 CM	52102-23A	52102-23B
	36 CM	52103-23A	52103-23B
	45 CM	52101-23A	52101-23B

Recommended

Optional



Type 1:  
Insulated Stainless  
Steel w/ RF Post



Type 3:  
Non-Insulated  
Stainless Steel

OR



Type 5:  
Lightweight Carbon  
-Fiber w/ RF Post



Type 7:  
Lightweight  
Carbon-Fiber w/  
RF Post, Ratchet /  
Ratchet Defeating

OR



Type 17:  
Lightweight Carbon  
-Fiber w/ RF Post



Type 9:  
Lightweight  
Carbon-Fiber w/  
RF Post, w/ Large  
Finger Loops



Type 18:  
Carbon-Fiber w/  
RF Post, Ratchet /  
Ratchet Defeating

**STYLE A:**  
RIGID, ONE-PIECE INSTRUMENT WITH  
FLUSH PORT



**STYLE B:**  
ROTATABLE, ONE-PIECE INSTRUMENT  
WITH FLUSH PORT

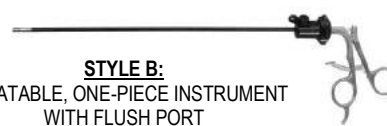

	<u>Length</u>	<u>Style A:</u>	<u>Style B:</u>
10MM, KOCHER GRASPER, 40MM JAW, AXIAL SERRATIONS	33 CM	52102-24A	52102-24B
	36 CM	52103-24A	52103-24B
	45 CM	52101-24A	52101-24B
10MM, KOCHER GRASPER, 60MM JAW, AXIAL SERRATIONS	33 CM	52102-25A	52102-25B
	36 CM	52103-25A	52103-25B
	45 CM	52101-25A	52101-25B
10MM, DUVAL GRASPER, 40 MM JAW, AXIAL SERRATIONS	33 CM	52102-26A	52102-26B
	36 CM	52103-26A	52103-26B
	45 CM	52101-26A	52101-26B
10MM, CLAW FORCEPS, 2 X 3 TEETH	33 CM	52102-36A	52102-36B
	36 CM	52103-36A	52103-36B
	45 CM	52101-36A	52101-36B
10MM, SPOON FORCEPS, STANDARD TIP	33 CM	52102-37A	52102-37B
	36 CM	52103-37A	52103-37B
	45 CM	52101-37A	52101-37B
10MM, SPOON FORCEPS, LONG TIP	33 CM	52102-38A	52102-38B
	36 CM	52103-38A	52103-38B
	45 CM	52101-38A	52101-38B
10MM, SCHROEDER TENACULUM FORCEPS, SINGLE TOOTH	33 CM	52102-45A	52102-45B
	36 CM	52103-45A	52103-45B
	45 CM	52101-45A	52101-45B
10MM, SCHROEDER TENACULUM FORCEPS "WISAP STYLE," SINGLE TOOTH W/ EXTRA GUIDE TOOTH	33 CM	52102-94A	52102-94B
	36 CM	52103-94A	52103-94B
	45 CM	52101-94A	52101-94B
10MM, STRONG ATRAUMATIC CLAMP, 40MM STRAIGHT JAW	33 CM	52102-46A	52102-46B
	36 CM	52103-46A	52103-46B
	45 CM	52101-46A	52101-46B
10MM, STRONG ATRAUMATIC CLAMP, 40MM CURVED JAW	33 CM	52102-47A	52102-47B
	36 CM	52136-47A	52136-47B
	45 CM	52101-47A	52101-47B

Recommended

Optional



Type 1:  
Insulated Stainless  
Steel w/ RF Post

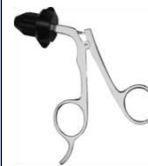

Type 3:  
Non-Insulated  
Stainless Steel

OR



Type 5:  
Lightweight Carbon  
-Fiber w/ RF Post



Type 7:  
Lightweight  
Carbon-Fiber w/  
RF Post, Ratchet /  
Ratchet Defeating

OR



Type 9:  
Lightweight Carbon  
-Fiber w/ RF Post



Type 17:  
Lightweight Carbon  
-Fiber w/ RF Post

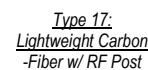

Type 18:  
Carbon-Fiber w/  
RF Post, Ratchet /  
Ratchet Defeating





**STYLE A:**  
RIGID, ONE-PIECE INSTRUMENT WITH FLUSH PORT



**STYLE B:**  
ROTATABLE, ONE-PIECE INSTRUMENT WITH FLUSH PORT



	<u>Length</u>	<u>Style A:</u>	<u>Style B:</u>
10MM, STRAIGHT SCISSORS, SINGLE ACTION	33 CM	52102-64A	52102-64B
	36 CM	52136-64A	52136-64B
	45 CM	52101-64A	52101-64B
10MM, CURVED SCISSORS, DOUBLE ACTION	33 CM	52102-67A	52102-67B
	36 CM	52136-67A	52136-67B
	45 CM	52101-67A	52101-67B

**Recommended**

**Optional**



Type 2:  
Insulated Stainless Steel w/ RF Post & Ratchet



Type 4:  
Non-Insulated Stainless Steel w/ Ratchet

**OR**



Type 6:  
Lightweight Carbon-Fiber w/ RF Post & Ratchet



Type 7:  
Lightweight Carbon-Fiber w/ RF Post, Ratchet / Ratchet Defeating

**OR**



Type 6:  
Lightweight Carbon-Fiber w/ RF Post, Ratchet / Ratchet Defeating w/ Large Finger Loops



Type 8:  
Lightweight Carbon-Fiber w/ RF Post, French On/Off Ratchet



Type 10:  
Lightweight Carbon-Fiber w/ RF Post, Ratchet / Ratchet Defeating w/ Large Finger Loops

Type 12:  
Stainless Steel Axial Handle w/ Ratchet

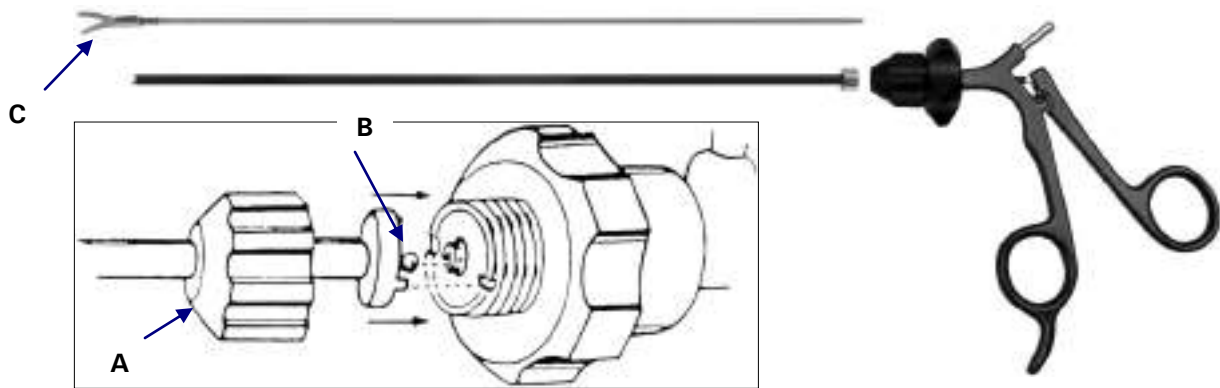

**ASSEMBLY:**

1. Turn the **Tip (C)** clockwise into the shaft
2. Set the handle in the open position & engage the **Ball (B)** of **Inner Rod** into its fixation in the handle port.
3. Turn main **Screw Cap (A)** clockwise until it engages the handle.



	<u>Length</u>	<u>Style C:</u>	<u>Insert Only::</u>
10MM, STRONG GRASPER/ DISSECTOR	33 CM	52102-02C	52102-02I
	36 CM	52103-02C	52103-02I
	45 CM	52101-02C	52101-02I
10MM, MARYLAND GRASPER/ DISSECTOR	33 CM	52102-06C	52102-06I
	36 CM	52103-06C	52103-06I
	45 CM	52101-06C	52101-06I
10MM, MIXTER GRASPER/ DISSECTOR, RIGHT ANGLE	33 CM	52102-07C	52102-07I
	36 CM	52103-07C	52103-07I
	45 CM	52101-07C	52101-07I
10MM, MIXTER GRASPER/ DISSECTOR, SHORT RIGHT ANGLE	33 CM	52102-59C	52102-59I
	36 CM	52103-59C	52103-59I
	45 CM	52101-59C	52101-59I
10MM, MIXTER GRASPER/ DISSECTOR, 45° ANGLE	33 CM	52102-08C	52102-08I
	36 CM	52103-08C	52103-08I
	45 CM	52101-08C	52101-08I
10MM, BABCOCK GRASPER, FENESTRATED TIP	33 CM	52102-16C	52102-16I
	36 CM	52103-16C	52103-16I
	45 CM	52101-16C	52101-16I
US BABCOCK GRASPER, SPRING TENSION, ATRAUMATIC	33 CM	52102-17C	52102-17I
	36 CM	52103-17C	52103-17I
	45 CM	52101-17C	52101-17I
10MM, ALLIS GRASPER, FINE AXIAL SERRATIONS	33 CM	52102-21C	52102-21I
	36 CM	52103-21C	52103-21I
	45 CM	52101-21C	52101-21I
10MM, DEBAKEY GRASPER, 40 MM JAW	33 CM	52102-22C	52102-22I
	36 CM	52103-22C	52103-22I
	45 CM	52101-22C	52101-22I
10MM, DEBAKEY GRASPER, 60 MM JAW	33 CM	52102-23C	52102-23I
	36 CM	52103-23C	52103-23I
	45 CM	52101-23C	52101-23I

Recommended

Optional



Type 1:  
Insulated Stainless  
Steel w/ RF Post

Type 3:  
Non-Insulated  
Stainless Steel

OR



Type 5:  
Lightweight Carbon  
-Fiber w/ RF Post

Type 7:  
Lightweight  
Carbon-Fiber w/  
RF Post, Ratchet /  
Ratchet Defeating

OR



Type 17:  
Lightweight Carbon  
-Fiber w/ RF Post

Type 9:  
Lightweight  
Carbon-Fiber w/  
RF Post, w/ Large  
Finger Loops



Type 18:  
Carbon-Fiber w/  
RF Post, Ratchet /  
Ratchet Defeating



	<u>Length</u>	<u>Style C:</u>	<u>Insert Only::</u>
10MM, KOCHER GRASPER, 40MM JAW, AXIAL SERRATIONS	33 CM	52102-24C	52102-24I
	36 CM	52103-24C	52103-24I
	45 CM	52101-24C	52101-24I
10MM, KOCHER GRASPER, 60MM JAW, AXIAL SERRATIONS	33 CM	52102-25C	52102-25I
	36 CM	52103-25C	52103-25I
	45 CM	52101-25C	52101-25I
10MM, DUVAL GRASPER, 40MM JAW, AXIAL SERRATIONS	33 CM	52102-26C	52102-26I
	36 CM	52103-26C	52103-26I
	45 CM	52101-26C	52101-26I
10MM, CLAW FORCEPS, 2 X 3 TEETH	33 CM	52102-36C	52102-36I
	36 CM	52103-36C	52103-36I
	45 CM	52101-36C	52101-36I
10MM, SPOON FORCEPS, STANDARD TIP	33 CM	52102-37C	52102-37I
	36 CM	52103-37C	52103-37I
	45 CM	52101-37C	52101-37I
10MM, SPOON FORCEPS, LONG TIP	33 CM	52102-38C	52102-38I
	36 CM	52103-38C	52103-38I
	45 CM	52101-38C	52101-38I
10MM, SCHROEDER TENACULUM FORCEPS, SINGLE TOOTH	33 CM	52102-45C	52102-45I
	36 CM	52103-45C	52103-45I
	45 CM	52101-45C	52101-45I
10MM, SCHROEDER TENACULUM FORCEPS "WISAP STYLE," SINGLE TOOTH W/ EXTRA GUIDE TOOTH	33 CM	52102-94C	52102-94I
	36 CM	52103-94C	52103-94I
	45 CM	52101-94C	52101-94I
10MM, STRONG ATRAUMATIC CLAMP, 40MM STRAIGHT JAW	33 CM	52102-46C	52102-46I
	36 CM	52103-46C	52103-46I
	45 CM	52101-46C	52101-46I
10MM, STRONG ATRAUMATIC CLAMP, 40MM CURVED JAW	33 CM	52102-47C	52102-47I
	36 CM	52136-47C	52136-47I
	45 CM	52101-47C	52101-47I

Recommended

Optional



Type 1:  
Insulated Stainless Steel w/ RF Post

OR



Type 5:  
Lightweight Carbon-Fiber w/ RF Post

OR



Type 17:  
Lightweight Carbon-Fiber w/ RF Post



Type 3:  
Non-Insulated Stainless Steel



Type 7:  
Lightweight Carbon-Fiber w/ RF Post, Ratchet / Ratchet Defeating



Type 9:  
Lightweight Carbon-Fiber w/ RF Post, w/ Large Finger Loops



Type 18:  
Carbon-Fiber w/ RF Post, Ratchet / Ratchet Defeating

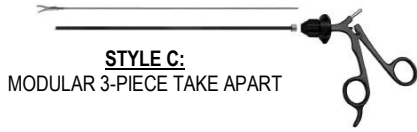

10MM, STRAIGHT SCISSORS,  
SINGLE ACTION

10MM, CURVED SCISSORS,  
DOUBLE ACTION

<u>Length</u>	<u>Style C:</u>	<u>Insert Only::</u>
33 CM	52102-64C	52102-64I
36 CM	52136-64C	52136-64I
45 CM	52101-64C	52101-64I
33 CM	52102-67C	52102-67I
36 CM	52136-67C	52136-67I
45 CM	52101-67C	52101-67I

**Recommended**

**Optional**



Type 2:  
Insulated Stainless  
Steel w/ RF Post &  
Ratchet



Type 4:  
Non-Insulated  
Stainless Steel w/  
Ratchet

**OR**



Type 6:  
Lightweight Carbon  
-Fiber w/ RF Post  
& Ratchet



Type 7:  
Lightweight  
Carbon-Fiber w/  
RF Post, Ratchet /  
Ratchet Defeating

**OR**



Type 10:  
Lightweight  
Carbon-Fiber w/  
RF Post, Ratchet /  
Ratchet Defeating  
w/ Large Finger  
Loops



Type 8:  
Lightweight  
Carbon-Fiber w/  
RF Post, French  
On/Off Ratchet



Type 12:  
Stainless Steel  
Axial Handle w/  
Ratchet





**TYPE 1:**  
INSULATED WITH RF-  
POST



**TYPE 2:**  
INSULATED W/ RF-  
POST & RATCHET



**TYPE 3:**  
NON-INSULATED  
STAINLESS STEEL



**TYPE 4:**  
NON-INSULATED  
STAINLESS STEEL W/  
RATCHET



**TYPE 5:**  
LIGHTWEIGHT  
CARBON-FIBER W/ RF  
POST



**TYPE 6:**  
LIGHTWEIGHT  
CARBON-FIBER  
w/ RF-POST &  
RATCHET



**TYPE 7:**  
LIGHTWEIGHT  
CARBON-FIBER  
W/ RF POST,  
RATCHET /  
RATCHET  
DEFEATING



**TYPE 8:**  
LIGHTWEIGHT CARBON  
-FIBER W/ RF POST,  
FRENCH ON/OFF  
RATCHET



**TYPE 9:**  
LIGHTWEIGHT  
CARBON-FIBER W/ RF  
POST, W/ LARGE  
FINGER LOOPS



**TYPE 10:**  
LIGHTWEIGHT  
CARBON-FIBER W/ RF  
POST, RATCHET /  
RATCHET DEFEATING  
W/ LARGE FINGER  
LOOPS

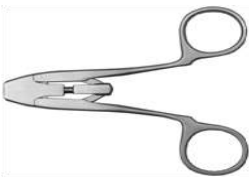

**TYPE 11:**  
STAINLESS STEEL RING  
AXIAL HANDLE



**TYPE 12:**  
STAINLESS STEEL RING AXIAL  
HANDLE W/ RATCHET

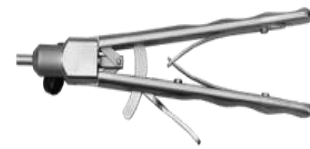

**TYPE 13:**  
STAINLESS STEEL AXIAL HANDLE  
w/ PRECISE ENGAGEMENT  
RATCHET



**TYPE 14:**  
INSULATED STAINLESS  
STEEL LINVATEC-WECK  
STYLE W/ LONG  
SHANKS



**TYPE 15:**  
NON-INSULATED  
STAINLESS STEEL  
LINVATEC-WECK STYLE  
W/ QUICK RELEASE  
RATCHET & LONG  
SHANKS



**TYPE 16:**  
NON-INSULATED  
STAINLESS STEEL W/  
SPRING ASSIST  
CLOSING



**TYPE 18:**  
CARBON-FIBER W/ RF  
POST



**TYPE 18:**  
CARBON-FIBER W/ RF  
POST, RATCHET /  
RATCHET DEFEATING



	<u>Length</u>	<u>Style A:</u>	<u>Style B:</u>	<u>Style C:</u>
STANDARD GRASPER W/ SPOON, DOUBLE-ACTION, STRAIGHT SERRATED JAWS W/ PROXIMAL RECESS SPOON, DOUBLE-ACTION, INSULATED SHAFT	33 CM	52605-02A	52605-02B	52605-02C
	36 CM	52636-02A	52636-02B	52636-02C
	45 CM	52615-02A	52615-02B	52615-02C
	24 CM	52624-02A	52624-02B	52624-02C
STANDARD GRASPER W/SERRATED JAWS FOR MAX GRIP, DOUBLE-ACTION, INSULATED SHAFT	33 CM	52605-03A	52605-03B	52605-03C
	36 CM	52636-03A	52636-03B	52636-03C
	45 CM	52615-03A	52615-03B	52615-03C
	24 CM	52624-03A	52624-03B	52624-03C
5MM Ø, TAPERED DOLPHIN-NOSE GRASPER/DISSECTOR	33 CM	52605-04A	52605-04B	52605-04C
	36 CM	52636-04A	52636-04B	52636-04C
	45 CM	52615-04A	52615-04B	52615-04C
	24 CM	52624-04A	52624-04B	52624-04C
5MM Ø, TAPERED DOLPHIN-NOSE GRASPER/DISSECTOR W/ SPOON	33 CM	52605-104A	52605-104B	52605-104C
	36 CM	52636-104A	52636-104B	52636-104C
	45 CM	52615-104A	52615-104B	52615-104C
	24 CM	52624-104A	52624-104B	52624-104C
5MM Ø, COBRA GRASPER, DOUBLE-ACTION	33 CM	52605-15A	52605-15B	52605-15C
	36 CM	52636-15A	52636-15B	52636-15C
	45 CM	52615-15A	52615-15B	52615-15C
	24 CM	52624-15A	52624-15B	52624-15C
BABCOCK GRASPER W/ FENESTRATED TIP, TRADITIONAL DESIGN FOR GRASPING DELICATE TISSUE, DOUBLE-ACTION, INSULATED SHAFT	33 CM	52605-16A	52605-16B	52605-16C
	36 CM	52636-16A	52636-16B	52636-16C
	45 CM	52615-16A	52615-16B	52615-16C
	24 CM	52624-16A	52624-16B	52624-16C
5MM Ø, BABCOCK GRASPER, AXIS STYLE, FENESTRATED TIP	33 CM	52605-116A	52605-116B	52605-116C
	36 CM	52636-116A	52636-116B	52636-116C
	45 CM	52615-116A	52615-116B	52615-116C
	24 CM	52624-116A	52624-116B	52624-116C
5MM Ø, BABCOCK GRASPER-SHORT: DELICATE APPLICATION	33 CM	52605-17A	52605-17B	52605-17C
	36 CM	52636-17A	52636-17B	52636-17C
	45 CM	52615-17A	52615-17B	52615-17C
	24 CM	52624-17A	52624-17B	52624-17C
5MM Ø, ALLIS GRASPER, SHORT VERSION, SINGLE ACTION	33 CM	52605-18A	52605-18B	52605-18C
	36 CM	52636-18A	52636-18B	52636-18C
	45 CM	52615-18A	52615-18B	52615-18C
	24 CM	52624-18A	52624-18B	52624-18C
5MM Ø, ALLIS GRASPER, SHORT VERSION, 3 X 4 TEETH, SERRATED, DOUBLE-ACTION	33 CM	52605-19A	52605-19B	52605-19C
	36 CM	52636-19A	52636-19B	52636-19C
	45 CM	52615-19A	52615-19B	52615-19C
	24 CM	52624-19A	52624-19B	52624-19C

We offer complete solution for Electrosurgical Accessories for hospital at the right price.



**STYLE A:**  
RIGID, ONE-PIECE INSTRUMENT WITH FLUSH PORT



**STYLE B:**  
ROTATABLE, ONE-PIECE INSTRUMENT WITH FLUSH PORT













**STYLE C:**  
MODULAR 3-PIECE TAKE APART



5MM Ø, ATRAUMATIC ALLIS GRASPER, SHORT VERSION, SERRATED W/ DOUBLE ROW OF TEETH, DOUBLE-ACTION	33 CM	52605-119A	52605-119B	52605-119C
	36 CM	52636-119A	52636-119B	52636-119C
	45 CM	52615-119A	52615-119B	52615-119C
	24 CM	52624-119A	52624-119B	52624-119C
5MM Ø, ATRAUMATIC ALLIS GRASPER, LONG VERSION, SERRATED W/ DOUBLE ROW OF TEETH, DOUBLE-ACTION	33 CM	52605-219A	52605-219B	52605-219C
	36 CM	52636-219A	52636-219B	52636-219C
	45 CM	52615-219A	52615-219B	52615-219C
	24 CM	52624-219A	52624-219B	52624-219C
ALLIS GRASPER, MEDIUM VERSION, UNIQUE TEETH DESIGN FOR ATRAUMATIC STRONG HOLD, DOUBLE-ACTION, INSULATED SHAFT	33 CM	52605-20A	52605-20B	52605-20C
	36 CM	52636-20A	52636-20B	52636-20C
	45 CM	52615-20A	52615-20B	52615-20C
	24 CM	52624-20A	52624-20B	52624-20C
ALLIS GRASPER, STANDARD VERSION, LONG UNIQUE TEETH DESIGN FOR ATRAUMATIC STRONG HOLD, DOUBLE-ACTION, INSULATED SHAFT STANDARD GRASPER W/SERRATED JAWS FOR MAX GRIP, DOUBLE-ACTION, INSULATED SHAFT	33 CM	52605-21A	52605-21B	52605-21C
	36 CM	52636-21A	52636-21B	52636-21C
	45 CM	52615-21A	52615-21B	52615-21C
	24 CM	52624-21A	52624-21B	52624-21C
DEBAKEY GRASPER, 20MM LONG JAW, TRADITIONAL DEBAKEY-TYPE TEETH FOR PRECISE ATRAUMATIC GRASPING, DOUBLE-ACTION, INSULATED SHAFT	33 CM	52605-22A	52605-22B	52605-22C
	36 CM	52636-22A	52636-22B	52636-22C
	45 CM	52615-22A	52615-22B	52615-22C
	24 CM	52624-22A	52624-22B	52624-22C
DEBAKEY GRASPER, 40MM LONG JAW, TRADITIONAL DEBAKEY-TYPE TEETH FOR PRECISE ATRAUMATIC GRASPING, DOUBLE-ACTION, INSULATED SHAFT	33 CM	52605-23A	52605-23B	52605-23C
	36 CM	52636-23A	52636-23B	52636-23C
	45 CM	52615-23A	52615-23B	52615-23C
	24 CM	52624-23A	52624-23B	52624-23C
DEBAKEY GRASPER, 60MM LONG JAW, TRADITIONAL DEBAKEY-TYPE TEETH FOR PRECISE ATRAUMATIC GRASPING, DOUBLE-ACTION, INSULATED SHAFT	33 CM	52605-124A	52605-124B	52605-124C
	36 CM	52636-124A	52636-124B	52636-124C
	45 CM	52615-124A	52615-124B	52615-124C
	24 CM	52624-124A	52624-124B	52624-124C
5MM Ø, GLASSMAN ATRAUMATIC GRASPER	33 CM	52605-24A	52605-24B	52605-24C
	36 CM	52636-24A	52636-24B	52636-24C
	45 CM	52615-24A	52615-24B	52615-24C
	24 CM	52624-24A	52624-24B	52624-24C
DOUBLE-CUP FUNDUS MAXI GRASPER, DOUBLE CUP DESIGN INCREASES SURFACE AREA CONTENT IMPROVING TISSUE HOLD, DOUBLE-ACTION, INSULATED SHAFT	33 CM	52605-26A	52605-26B	52605-26C
	36 CM	52636-26A	52636-26B	52636-26C
	45 CM	52615-26A	52615-26B	52615-26C
	24 CM	52624-26A	52624-26B	52624-26C
ENDO CLINCH FENESTRATED GRASPER, LONG FENESTRATED JAW WITH INTERLOCKING WAVE-LIKE TEETH FOR STRONG HOLD, DOUBLE-ACTION, INSULATED SHAFT	33 CM	52605-27A	52605-27B	52605-27C
	36 CM	52636-27A	52636-27B	52636-27C
	45 CM	52615-27A	52615-27B	52615-27C
	24 CM	52624-27A	52624-27B	52624-27C









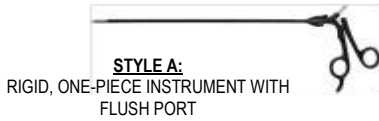

We offer complete solution for Electrosurgical Accessories for hospital at the right price.



	<i>Length</i>	<i>Style A:</i>	<i>Style B:</i>	<i>Style C:</i>
	33 CM	52605-28A	52605-28B	52605-28C
	36 CM	52636-28A	52636-28B	52636-28C
	45 CM	52615-28A	52615-28B	52615-28C
	24 CM	52624-28A	52624-28B	52624-28C
	33 CM	52605-32A	52605-32B	52605-32C
	36 CM	52636-32A	52636-32B	52636-32C
	45 CM	52615-32A	52615-32B	52615-32C
	24 CM	52624-32A	52624-32B	52624-32C
	33 CM	52605-33A	52605-33B	52605-33C
	36 CM	52636-33A	52636-33B	52636-33C
	45 CM	52615-33A	52615-33B	52615-33C
	24 CM	52624-33A	52624-33B	52624-33C
	33 CM	52605-34A	52605-34B	52605-34C
	36 CM	52636-34A	52636-34B	52636-34C
	45 CM	52615-34A	52615-34B	52615-34C
	24 CM	52624-34A	52624-34B	52624-34C
	33 CM	52605-35A	52605-35B	52605-35C
	36 CM	52636-35A	52636-35B	52636-35C
	45 CM	52615-35A	52615-35B	52615-35C
	24 CM	52624-35A	52624-35B	52624-35C
	33 CM	52605-134A	52605-134B	52605-134C
	36 CM	52636-134A	52636-134B	52636-134C
	45 CM	52615-134A	52615-134B	52615-134C
	24 CM	52624-134A	52624-134B	52624-134C
	33 CM	52605-135A	52605-135B	52605-135C
	36 CM	52636-135A	52636-135B	52636-135C
	45 CM	52615-135A	52615-135B	52615-135C
	24 CM	52624-135A	52624-135B	52624-135C
	33 CM	52605-39A	52605-39B	52605-39C
	36 CM	52636-39A	52636-39B	52636-39C
	45 CM	52615-39A	52615-39B	52615-39C
	24 CM	52624-39A	52624-39B	52624-39C
	33 CM	52605-40A	52605-40B	52605-40C
	36 CM	52636-40A	52636-40B	52636-40C
	45 CM	52615-40A	52615-40B	52615-40C
	24 CM	52624-40A	52624-40B	52624-40C
	33 CM	52605-41A	52605-41B	52605-41C
	36 CM	52636-41A	52636-41B	52636-41C
	45 CM	52615-41A	52615-41B	52615-41C
	24 CM	52624-41A	52624-41B	52624-41C

*We offer complete solution for Electrosurgical Accessories for hospital at the right price.*



	<u>Length</u>	<u>Style A:</u>	<u>Style B:</u>	<u>Style C:</u>
 FENESTRATED GRASPER, 40 MM, STRAIGHT SERRATED JAWS W/ LONG FENESTRATION FOR ATRAUMATIC GRIP, SINGLE-ACTION, INSULATED SHAFT	33 CM	52605-42A	52605-42B	52605-42C
	36 CM	52636-42A	52636-42B	52636-42C
	45 CM	52615-42A	52615-42B	52615-42C
	24 CM	52624-42A	52624-42B	52624-42C
 SCHROEDER TENACULUM GRASPER, SINGE-TOOTH LONG JAW FOR MAXIMUM GRASP OF THICK TISSUE, DOUBLE-ACTION, INSULATED SHAFT	33 CM	52605-45A	52605-45B	52605-45C
	36 CM	52636-45A	52636-45B	52636-45C
	45 CM	52615-45A	52615-45B	52615-45C
	24 CM	52624-45A	52624-45B	52624-45C
 DEBAKEY CURVED GRASPER W/ ATRAUMATIC TEETH, FOR PRECISE ATRAUMATIC GRIP, DOUBLE-ACTION, INSULATED SHAFT	33 CM	52605-46A	52605-46B	52605-46C
	36 CM	52636-46A	52636-46B	52636-46C
	45 CM	52615-46A	52615-46B	52615-46C
	24 CM	52624-46A	52624-46B	52624-46C
 HUNTER BOWEL GRASPER, 22 MM JAW, FENESTRATED JAW W/ DEBAKEY-TYPE TEETH FOR ATRAUMATIC MANIPULATION OF DELICATE TISSUE E.G. BOWEL, STOMACH; DOUBLE-ACTION, INSULATED SHAFT	33 CM	52605-58A	52605-58B	52605-58C
	36 CM	52636-58A	52636-58B	52636-58C
	45 CM	52615-58A	52615-58B	52615-58C
	24 CM	52624-58A	52624-58B	52624-58C
 HUNTER BOWEL GRASPER, 40 MM JAW, FENESTRATED JAW W/ DEBAKEY-TYPE TEETH FOR ATRAUMATIC MANIPULATION OF DELICATE TISSUE E.G. BOWEL, STOMACH; DBL-ACTION, INSULATED SHAFT	33 CM	52605-159A	52605-159B	52605-159C
	36 CM	52636-159A	52636-159B	52636-159C
	45 CM	52615-159A	52615-159B	52615-159C
	24 CM	52624-159A	52624-159B	52624-159C
 HUNTER BOWEL GRASPER, 60 MM JAW, FENESTRATED JAW W/ DEBAKEY-TYPE TEETH FOR ATRAUMATIC MANIPULATION OF DELICATE TISSUE E.G. BOWEL, STOMACH; DBL-ACTION, INSULATED SHAFT	33 CM	52605-160A	52605-160B	52605-160C
	36 CM	52636-160A	52636-160B	52636-160C
	45 CM	52615-160A	52615-160B	52615-160C
	24 CM	52624-160A	52624-160B	52624-160C
 THE POPULAR "DAVOL" TYPE, ATRAUMATIC GRASPER, SCOOPED-OUT JAW & GENTLY MASHING TEETH, EASY ON TISSUE & EXCELLENT HOLDING; DOUBLE-ACTION, INSULATED SHAFT	33 CM	52605-90A	52605-90B	52605-90C
	36 CM	52636-90A	52636-90B	52636-90C
	45 CM	52615-90A	52615-90B	52615-90C
	24 CM	52624-90A	52624-90B	52624-90C
 5MM Ø, "ACCESS" TYPE, FENESTRATED GRASPER, 20MM JAW W/ AGGRESSIVE TEETH FOR POSITIVE EXTRA STRONG TISSUE HOLDING	33 CM	52605-91A	52605-91B	52605-91C
	36 CM	52636-91A	52636-91B	52636-91C
	45 CM	52615-91A	52615-91B	52615-91C
	24 CM	52624-91A	52624-91B	52624-91C
 "SOFT TOUCH" GRASPER, 22 MM JAW, ATRAUMATIC TEFLON INSERTS FOR THE LIGHT MINIMUM TISSUE TRAUMA TOUCH YET W/ POSITIVE HOLDING; DOUBLE-ACTION, INSULATED SHAFT	33 CM	52605-92A	52605-92B	52605-92C
	36 CM	52636-92A	52636-92B	52636-92C
	45 CM	52615-92A	52615-92B	52615-92C
	24 CM	52624-92A	52624-92B	52624-92C
 "SOFT TOUCH" GRASPER 40 MM JAW, ATRAUMATIC TEFLON INSERTS FOR THE LIGHT MINIMUM TISSUE TRAUMA TOUCH YET W/ POSITIVE HOLDING; DOUBLE-ACTION, INSULATED SHAFT	33 CM	52605-93A	52605-93B	52605-93C
	36 CM	52636-93A	52636-93B	52636-93C
	45 CM	52615-93A	52615-93B	52615-93C
	24 CM	52624-93A	52624-93B	52624-93C



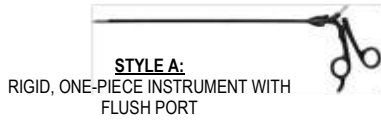





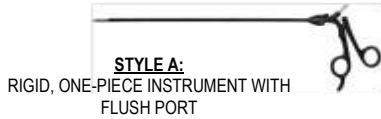

We offer complete solution for Electrosurgical Accessories for hospital at the right price.



	<u>Length</u>	<u>Style A:</u>	<u>Style B:</u>	<u>Style C:</u>	
	STANDARD GRASPER W/ SPOON, DOUBLE-ACTION, STRAIGHT SERRATED JAWS W/ PROXIMAL RECESS SPOON, DOUBLE-ACTION, INSULATED SHAFT	33 CM	52610-02A	52610-02B	52610-02C
		36 CM	52612-02A	52612-02B	52612-02C
		45 CM	52611-02A	52611-02B	52611-02C
	STANDARD GRASPER W/SERRATED JAWS FOR MAX GRIP, DOUBLE-ACTION, INSULATED SHAFT	33 CM	52610-03A	52610-03B	52610-03C
		36 CM	52612-03A	52612-03B	52612-03C
		45 CM	52611-03A	52611-03B	52611-03C
	BABCOCK GRASPER W/ FENESTRATED TIP, TRADITIONAL DESIGN FOR GRASPING DELICATE TISSUE, DOUBLE-ACTION, INSULATED SHAFT	33 CM	52610-16A	52610-16B	52610-16C
		36 CM	52612-16A	52612-16B	52612-16C
		45 CM	52611-16A	52611-16B	52611-16C
	ALLIS GRASPER, MEDIUM VERSION, UNIQUE TEETH DESIGN FOR ATRAUMATIC STRONG HOLD, DOUBLE-ACTION, INSULATED SHAFT	33 CM	52610-20A	52610-20B	52610-20C
		36 CM	52612-20A	52612-20B	52612-20C
		45 CM	52611-20A	52611-20B	52611-20C
	ALLIS GRASPER, STANDARD VERSION, LONG UNIQUE TEETH DESIGN FOR ATRAUMATIC STRONG HOLD, DOUBLE-ACTION, INSULATED SHAFT STANDARD GRASPER W/SERRATED JAWS FOR MAX GRIP, DOUBLE-ACTION, INSULATED SHAFT	33 CM	52610-21A	52610-21B	52610-21C
		36 CM	52612-21A	52612-21B	52612-21C
		45 CM	52611-21A	52611-21B	52611-21C
	DEBAKEY GRASPER, 20MM LONG JAW, TRADITIONAL DEBAKEY-TYPE TEETH FOR PRECISE ATRAUMATIC GRASPING, DOUBLE-ACTION, INSULATED SHAFT	33 CM	52610-22A	52610-22B	52610-22C
		36 CM	52612-22A	52612-22B	52612-22C
		45 CM	52611-22A	52611-22B	52611-22C
	DEBAKEY GRASPER, 40MM LONG JAW, TRADITIONAL DEBAKEY-TYPE TEETH FOR PRECISE ATRAUMATIC GRASPING, DOUBLE-ACTION, INSULATED SHAFT	33 CM	52610-23A	52610-23B	52610-23C
		36 CM	52612-23A	52612-23B	52612-23C
		45 CM	52611-23A	52611-23B	52611-23C
	DEBAKEY GRASPER, 60MM LONG JAW, TRADITIONAL DEBAKEY-TYPE TEETH FOR PRECISE ATRAUMATIC GRASPING, DOUBLE-ACTION, INSULATED SHAFT	33 CM	52610-124A	52610-124B	52610-124C
		36 CM	52612-124A	52612-124B	52612-124C
		45 CM	52611-124A	52611-124B	52611-124C
	DOUBLE-CUP FUNDUS MAXI GRASPER, DOUBLE CUP DESIGN INCREASES SURFACE AREA CONTENT IMPROVING TISSUE HOLD, DOUBLE-ACTION, INSULATED SHAFT	33 CM	52610-26A	52610-26B	52610-26C
		36 CM	52612-26A	52612-26B	52612-26C
		45 CM	52611-26A	52611-26B	52611-26C
	ENDO CLINCH FENESTRATED GRASPER, LONG FENESTRATED JAW WITH INTERLOCKING WAVE-LIKE TEETH FOR STRONG HOLD, DOUBLE-ACTION, INSULATED SHAFT	33 CM	52610-27A	52610-27B	52610-27C
		36 CM	52612-27A	52612-27B	52612-27C
		45 CM	52611-27A	52611-27B	52611-27C

We offer complete solution for Electrosurgical Accessories for hospital at the right price.



	<i>Length</i>	<i>Style A:</i>	<i>Style B:</i>	<i>Style C:</i>
 RETRO-FACING RAT TOOTH GRASPER W/ ATRAUMATIC CUP, ATRAUMATIC STRONG GRASPER, DOUBLE-ACTION, INSULATED SHAFT	33 CM	52605-28A	52605-28B	52605-28C
	36 CM	52636-28A	52636-28B	52636-28C
	45 CM	52615-28A	52615-28B	52615-28C
	24 CM	52624-28A	52624-28B	52624-28C
 WAVE FUNDUS GRASPER, LONG BEVELED EDGE JAWS, FOR LARGE GRASP ON TISSUE, DOUBLE-ACTION, INSULATED SHAFT	33 CM	52605-32A	52605-32B	52605-32C
	36 CM	52636-32A	52636-32B	52636-32C
	45 CM	52615-32A	52615-32B	52615-32C
	24 CM	52624-32A	52624-32B	52624-32C
 WAVE FUNDUS GRASPER, LONG BEVELED EDGE JAWS, FOR LARGE GRASP ON TISSUE, SINGLE-ACTION, INSULATED SHAFT	33 CM	52605-33A	52605-33B	52605-33C
	36 CM	52636-33A	52636-33B	52636-33C
	45 CM	52615-33A	52615-33B	52615-33C
	24 CM	52624-33A	52624-33B	52624-33C
 5MM Ø, RETRACTION GRASPER, LONG RIDGED JAWS, 2 X 3 ATRAUMATIC TEETH, DOUBLE-ACTION	33 CM	52605-34A	52605-34B	52605-34C
	36 CM	52636-34A	52636-34B	52636-34C
	45 CM	52615-34A	52615-34B	52615-34C
	24 CM	52624-34A	52624-34B	52624-34C
 RETRACTION GRASPER, AGGRESSIVE 2X3 TEETH W/ ATRAUMATIC LONG RIDGED JAW FOR STRONG PRECISE GRIP, SINGLE-ACTION, INSULATED SHAFT	33 CM	52605-35A	52605-35B	52605-35C
	36 CM	52636-35A	52636-35B	52636-35C
	45 CM	52615-35A	52615-35B	52615-35C
	24 CM	52624-35A	52624-35B	52624-35C
 RETRACTION GRASPER, 2X3 TEETH W/ ATRAUMATIC LONG RIDGED JAW FOR STRONG PRECISE GRIP, DBL-ACTION, INSULATED SHAFT (JARIT STYLE)	33 CM	52605-134A	52605-134B	52605-134C
	36 CM	52636-134A	52636-134B	52636-134C
	45 CM	52615-134A	52615-134B	52615-134C
	24 CM	52624-134A	52624-134B	52624-134C
 RETRACTION GRASPER, 2X3 TEETH W/ ATRAUMATIC LONG RIDGED JAW FOR STRONG PRECISE GRIP, SINGLE-ACTION, INSULATED SHAFT (JARIT STYLE)	33 CM	52605-135A	52605-135B	52605-135C
	36 CM	52636-135A	52636-135B	52636-135C
	45 CM	52615-135A	52615-135B	52615-135C
	24 CM	52624-135A	52624-135B	52624-135C
 FENESTRATED GRASPER, 22 MM, STRAIGHT SERRATED JAWS W/ LONG FENESTRATION FOR ATRAUMATIC GRIP, DOUBLE- ACTION, INSULATED SHAFT	33 CM	52605-39A	52605-39B	52605-39C
	36 CM	52636-39A	52636-39B	52636-39C
	45 CM	52615-39A	52615-39B	52615-39C
	24 CM	52624-39A	52624-39B	52624-39C
 FENESTRATED GRASPER, 40 MM, STRAIGHT SERRATED JAWS W/ LONG FENESTRATION FOR ATRAUMATIC GRIP, DOUBLE- ACTION, INSULATED SHAFT	33 CM	52605-40A	52605-40B	52605-40C
	36 CM	52636-40A	52636-40B	52636-40C
	45 CM	52615-40A	52615-40B	52615-40C
	24 CM	52624-40A	52624-40B	52624-40C
 FENESTRATED GRASPER, 22 MM, STRAIGHT SERRATED JAWS W/ LONG FENESTRATION FOR ATRAUMATIC GRIP, SINGLE- ACTION, INSULATED SHAFT	33 CM	52605-41A	52605-41B	52605-41C
	36 CM	52636-41A	52636-41B	52636-41C
	45 CM	52615-41A	52615-41B	52615-41C
	24 CM	52624-41A	52624-41B	52624-41C

We offer complete solution for Electrosurgical Accessories for hospital at the right price.



**STYLE A:**  
RIGID, ONE-PIECE INSTRUMENT WITH FLUSH PORT



**STYLE B:**  
ROTATABLE, ONE-PIECE INSTRUMENT WITH FLUSH PORT



**STYLE C:**  
MODULAR 3-PIECE TAKE APART



	<u>Length</u>	<u>Style A:</u>	<u>Style B:</u>	<u>Style C:</u>
FENESTRATED GRASPER, 40 MM, STRAIGHT SERRATED JAWS W/ LONG FENESTRATION FOR ATRAUMATIC GRIP, SINGLE-ACTION, INSULATED SHAFT	33 CM	52605-42A	52605-42B	52605-42C
	36 CM	52636-42A	52636-42B	52636-42C
	45 CM	52615-42A	52615-42B	52615-42C
	24 CM	52624-42A	52624-42B	52624-42C
SCHROEDER TENACULUM GRASPER, SINGE-TOOTH LONG JAW FOR MAXIMUM GRASP OF THICK TISSUE, DOUBLE-ACTION, INSULATED SHAFT	33 CM	52605-45A	52605-45B	52605-45C
	36 CM	52636-45A	52636-45B	52636-45C
	45 CM	52615-45A	52615-45B	52615-45C
	24 CM	52624-45A	52624-45B	52624-45C
DEBAKEY CURVED GRASPER W/ ATRAUMATIC TEETH, FOR PRECISE ATRAUMATIC GRIP, DOUBLE-ACTION, INSULATED SHAFT	33 CM	52605-46A	52605-46B	52605-46C
	36 CM	52636-46A	52636-46B	52636-46C
	45 CM	52615-46A	52615-46B	52615-46C
	24 CM	52624-46A	52624-46B	52624-46C
HUNTER BOWEL GRASPER, 22 MM JAW, FENESTRATED JAW W/ DEBAKEY-TYPE TEETH FOR ATRAUMATIC MANIPULATION OF DELICATE TISSUE E.G. BOWEL, STOMACH; DOUBLE-ACTION, INSULATED SHAFT	33 CM	52605-58A	52605-58B	52605-58C
	36 CM	52636-58A	52636-58B	52636-58C
	45 CM	52615-58A	52615-58B	52615-58C
	24 CM	52624-58A	52624-58B	52624-58C
HUNTER BOWEL GRASPER, 40 MM JAW, FENESTRATED JAW W/ DEBAKEY-TYPE TEETH FOR ATRAUMATIC MANIPULATION OF DELICATE TISSUE E.G. BOWEL, STOMACH; DBL-ACTION, INSULATED SHAFT	33 CM	52605-159A	52605-159B	52605-159C
	36 CM	52636-159A	52636-159B	52636-159C
	45 CM	52615-159A	52615-159B	52615-159C
	24 CM	52624-159A	52624-159B	52624-159C
HUNTER BOWEL GRASPER, 60 MM JAW, FENESTRATED JAW W/ DEBAKEY-TYPE TEETH FOR ATRAUMATIC MANIPULATION OF DELICATE TISSUE E.G. BOWEL, STOMACH; DBL-ACTION, INSULATED SHAFT	33 CM	52605-160A	52605-160B	52605-160C
	36 CM	52636-160A	52636-160B	52636-160C
	45 CM	52615-160A	52615-160B	52615-160C
	24 CM	52624-160A	52624-160B	52624-160C
THE POPULAR "DAVOL" TYPE, ATRAUMATIC GRASPER, SCOOPED-OUT JAW & GENTLY MASHING TEETH, EASY ON TISSUE & EXCELLENT HOLDING; DOUBLE-ACTION, INSULATED SHAFT	33 CM	52605-90A	52605-90B	52605-90C
	36 CM	52636-90A	52636-90B	52636-90C
	45 CM	52615-90A	52615-90B	52615-90C
	24 CM	52624-90A	52624-90B	52624-90C
5MM Ø, "ACCESS" TYPE, FENESTRATED GRASPER, 20MM JAW W/ AGGRESSIVE TEETH FOR POSITIVE EXTRA STRONG TISSUE HOLDING	33 CM	52605-91A	52605-91B	52605-91C
	36 CM	52636-91A	52636-91B	52636-91C
	45 CM	52615-91A	52615-91B	52615-91C
	24 CM	52624-91A	52624-91B	52624-91C
"SOFT TOUCH" GRASPER, 22 MM JAW, ATRAUMATIC TEFLON INSERTS FOR THE LIGHT MINIMUM TISSUE TRAUMA TOUCH YET W/ POSITIVE HOLDING; DOUBLE-ACTION, INSULATED SHAFT	33 CM	52605-92A	52605-92B	52605-92C
	36 CM	52636-92A	52636-92B	52636-92C
	45 CM	52615-92A	52615-92B	52615-92C
	24 CM	52624-92A	52624-92B	52624-92C
"SOFT TOUCH" GRASPER 40 MM JAW, ATRAUMATIC TEFLON INSERTS FOR THE LIGHT MINIMUM TISSUE TRAUMA TOUCH YET W/ POSITIVE HOLDING; DOUBLE-ACTION, INSULATED SHAFT	33 CM	52605-93A	52605-93B	52605-93C
	36 CM	52636-93A	52636-93B	52636-93C
	45 CM	52615-93A	52615-93B	52615-93C
	24 CM	52624-93A	52624-93B	52624-93C

*We offer complete solution for Electrosurgical Accessories for hospital at the right price.*





All Stainless Steel Construction w/:  
 (A) Standard Handle,  
 (B) Spring Handle  
 (C) Ratchet Handle, 5mm with Cleaning Flushport



	<u>Length</u>	<u>Standard Handle:</u>	<u>Spring Handle:</u>	<u>Ratchet Handle</u>
HOOK SCISSORS	33 CM	52502-01A	52502-01B	52502-01C
	45 CM	52501-01A	52501-01B	52501-01C
PERITONEAL SCISSORS	33 CM	52502-02A	52502-02B	52502-02C
	45 CM	52501-02A	52501-02B	52501-02C
SERRATED SCISSORS	33 CM	52502-03A	52502-03B	52502-03C
	45 CM	52501-03A	52501-03B	52501-03C
METZENBAUM SCISSORS CURVED	33 CM	52502-04A	52502-04B	52502-04C
	45 CM	52501-04A	52501-04B	52501-04C
POINTED SPOON FORCEPS	33 CM	52502-05A	52502-05B	52502-05C
	45 CM	52501-05A	52501-05B	52501-05C
SPOON FORCEPS	33 CM	52502-06A	52502-06B	52502-06C
	45 CM	52501-06A	52501-06B	52501-06C
SPOON W/ TEETH	33 CM	52502-07A	52502-07B	52502-07C
	45 CM	52501-07A	52501-07B	52501-07C
DOUBLE-ACTION SPOON	33 CM	52502-08A	52502-08B	52502-08C
	45 CM	52501-08A	52501-08B	52501-08C
DBL-ACTION SPOON W/ TEETH	33 CM	52502-09A	52502-09B	52502-09C
	45 CM	52501-09A	52501-09B	52501-09C
PUNCH FORCEPS	33 CM	52502-10A	52502-10B	52502-10C
	45 CM	52501-10A	52501-10B	52501-10C
PUNCH FORCEPS W/ TEETH	33 CM	52502-11A	52502-11B	52502-11C
	45 CM	52501-11A	52501-11B	52501-11C
HOOK PUNCH	33 CM	52502-12A	52502-12B	52502-12C
	45 CM	52501-12A	52501-12B	52501-12C

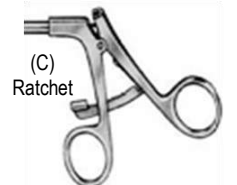
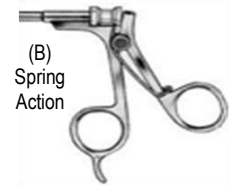
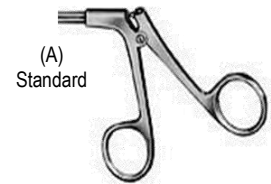



All Stainless Steel Construction w/:

- (A) Standard Handle,
- (B) Spring Handle
- (C) Ratchet Handle, 5mm with Cleaning Flushport



	<u>Length</u>	<u>Standard Handle:</u>	<u>Spring Handle:</u>	<u>Ratchet Handle</u>
STANDARD GRASPER W/ SPOON	33 CM	52502-13A	52502-13B	52502-13C
	45 CM	52501-13A	52501-13B	52501-13C
POINTED GRASPER W/ SPOON	33 CM	52502-14A	52502-14B	52502-14C
	45 CM	52501-14A	52501-14B	52501-14C
STANDARD GRASPER	33 CM	52502-15A	52502-15B	52502-15C
	45 CM	52501-15A	52501-15B	52501-15C
BACKBITING GRASPER	33 CM	52502-16A	52502-16B	52502-16C
	45 CM	52501-16A	52501-16B	52501-16C
ATRAUMATIC GRASPER	33 CM	52502-17A	52502-17B	52502-17C
	45 CM	52501-17A	52501-17B	52501-17C
CLAW GRASPER	33 CM	52502-18A	52502-18B	52502-18C
	45 CM	52501-18A	52501-18B	52501-18C
PETELIN DISSECTOR 60°	33 CM	52502-19A	52502-19B	52502-19C
	45 CM	52501-19A	52501-19B	52501-19C
PETELIN DISSECTOR 30°	33 CM	52502-20A	52502-20B	52502-20C
	45 CM	52501-20A	52501-20B	52501-20C
STRONG RIGHT ANGLE DISSECTOR	33 CM	52502-31A	52502-31B	52502-31C
	45 CM	52501-31A	52501-31B	52501-31C
HUNTER DEBAKEY	33 CM	52502-32A	52502-32B	52502-32C
	45 CM	52501-32A	52501-32B	52501-32C
SCHROEDER TENACULUM GRASPER, SINGLE TOOTH	33 CM	52502-33A	52502-33B	52502-33C
	45 CM	52501-33A	52501-33B	52501-33C

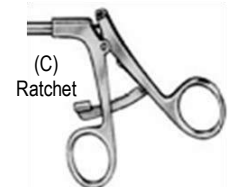
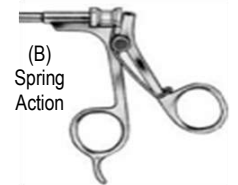
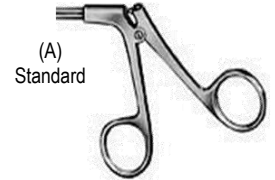

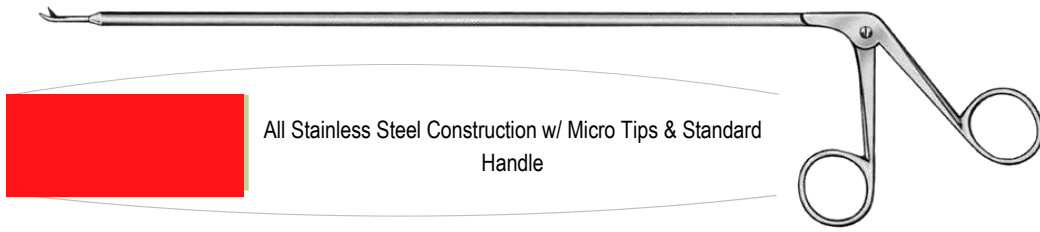

All Stainless Steel Construction w/ Micro Tips & Standard Handle



CURVED MICRO SCISSORS	33 CM	52502-01A
	45 CM	52501-01A



STRAIGHT MICRO SCISSORS	33 CM	52502-22
	45 CM	52501-22



MICRO GRASPER	33 CM	52502-23
	45 CM	52501-23



DBL-ACTION MICRO GRASPER	33 CM	52502-24
	45 CM	52501-24



MICRO BIOPSY PUNCH	33 CM	52502-25
	45 CM	52501-25

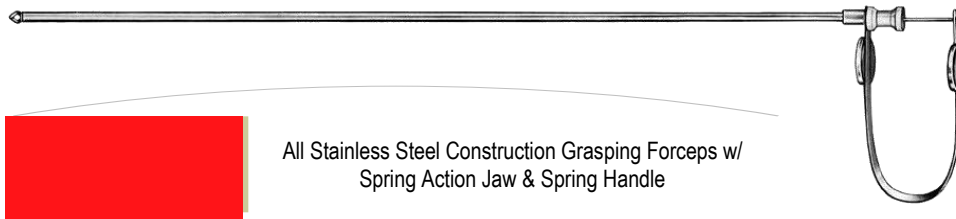

All Stainless Steel Construction Grasping Forceps w/ Spring Action Jaw & Spring Handle



STANDARD GRASPER	33 CM	52502-50
	45 CM	52501-50



ATRAMATIC GRASPER	33 CM	52502-51
	45 CM	52501-51



ATRAMATIC GRASPER W/ STRONG JAW	33 CM	52502-52
	45 CM	52501-52



ROUND BOWEL GRASPER	33 CM	52502-53
	45 CM	52501-53



"T" BOWEL GRASPER	33 CM	52502-54
	45 CM	52501-54



CYST GRASPER	33 CM	52502-55
	45 CM	52501-55



TUBAL GRASPER	33 CM	52502-56
	45 CM	52501-56



FENESTRATED GRASPER	33 CM	52502-57
	45 CM	52501-57

We offer complete solution for Electrosurgical Accessories for hospital at the right price.

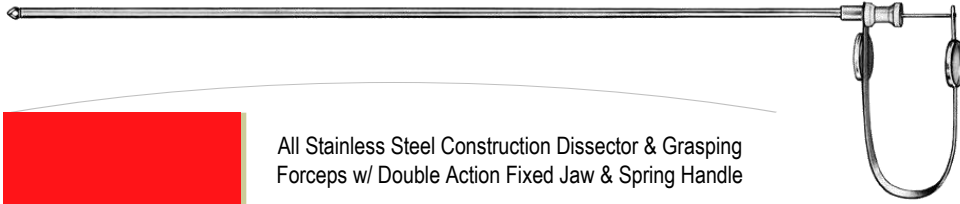

All Stainless Steel Construction Dissector & Grasping Forceps w/ Double Action Fixed Jaw & Spring Handle



ADHESION SEPARATOR	33 CM	52502-60
	45 CM	52501-60



RIGHT ANGLE DISSECTOR	33 CM	52502-61
	45 CM	52501-61



ATRAMATIC MICRO GRASPER	33 CM	52502-63
	45 CM	52501-63



BOWEL GRASPER	33 CM	52502-62
	45 CM	52501-62

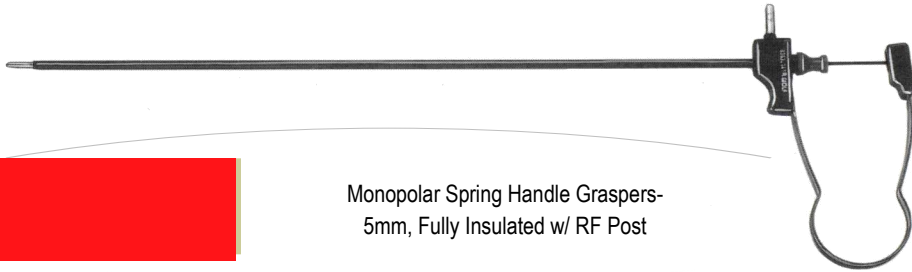

Monopolar Spring Handle Graspers- 5mm, Fully Insulated w/ RF Post



FENESTRATED GRASPER	33 CM	52502-70
	45 CM	52501-70



ATRAUMATIC GRASPER	33 CM	52502-71
	45 CM	52501-71



ATRAUMATIC FINE STRUCTURE GRASPER	33 CM	52502-72
	45 CM	52501-72

We offer complete solution for Electrosurgical Accessories for hospital at the right price.



*All Stainless Steel Construction w/:*

- (A) Standard Handle,
- (B) Spring Handle
- (C) Ratchet Handle, 5mm with Cleaning Flushport



	<u>Length</u>	<u>Standard Handle:</u>	<u>Spring Handle:</u>	<u>Ratchet Handle</u>
STRAIGHT SCISSORS	33 CM	52112-01A	52112-01B	52112-01C
	45 CM	52111-01A	52111-01B	52111-01C
SPOON FORCEPS	33 CM	52112-02A	52112-02B	52112-02C
	45 CM	52111-02A	52111-02B	52111-02C
CLAW FORCEPS	33 CM	52112-03A	52112-03B	52112-03C
	45 CM	52111-03A	52111-03B	52111-03C
GRASPING FORCEPS	33 CM	52112-04A	52112-04B	52112-04C
	45 CM	52111-04A	52111-04B	52111-04C
DEBAKEY STRAIGHT	33 CM	52502-05A	52502-05B	52502-05C
	45 CM	52501-05A	52501-05B	52501-05C
CLAW GRASPER	33 CM	52502-18A	52502-18B	52502-18C
	45 CM	52501-18A	52501-18B	52501-18C
PETELIN DISSECTOR 60°	33 CM	52502-19A	52502-19B	52502-19C
	45 CM	52501-19A	52501-19B	52501-19C
PETELIN DISSECTOR 30°	33 CM	52502-20A	52502-20B	52502-20C
	45 CM	52501-20A	52501-20B	52501-20C
STRONG RIGHT ANGLE DISSECTOR	33 CM	52502-31A	52502-31B	52502-31C
	45 CM	52501-31A	52501-31B	52501-31C
HUNTER DEBAKEY	33 CM	52502-32A	52502-32B	52502-32C
	45 CM	52501-32A	52501-32B	52501-32C
SCHROEDER TENACULUM GRASPER, SINGLE TOOTH	33 CM	52502-33A	52502-33B	52502-33C
	45 CM	52501-33A	52501-33B	52501-33C
GLASSMAN STRAIGHT	33 CM	52112-16A	52112-16B	52112-16C
	45 CM	52111-16A	52111-16B	52111-16C

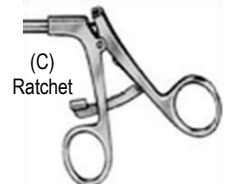
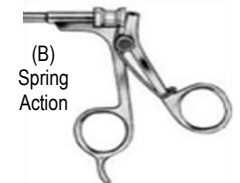

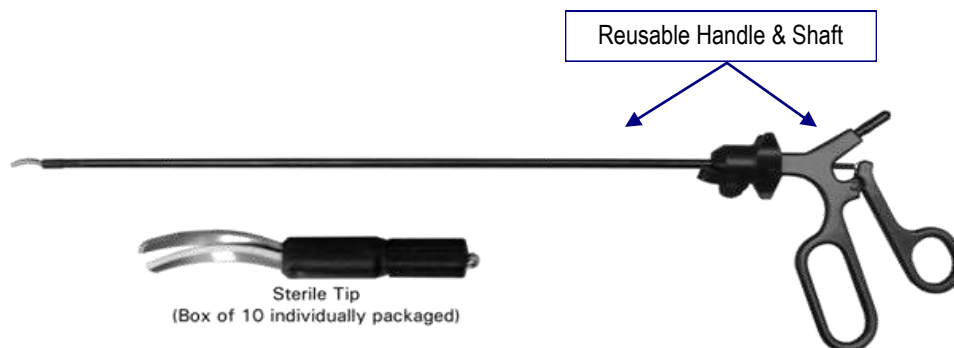

LIST NO. 52601-05	5MM DIA., 33CM INSULATED STAINLESS STEEL HANDLE & SHAFT, ROTATABLE 1-PIECE w/ FLUSH PORT
LIST NO. 52601-06	5MM DIA., 45CM INSULATED STAINLESS STEEL HANDLE & SHAFT, ROTATABLE 1-PIECE w/ FLUSH PORT
LIST NO. 52600-01	TIP ONLY, CURVED METZENBAUM SCISSORS-STERILE (PKG. OF 10)
LIST NO. 52600-02	TIP ONLY, STRAIGHT METZENBAUM SCISSORS-STERILE (PKG. OF 10)
LIST NO. 52600-03	TIP ONLY, MARYLAND GRASPER-STERILE (PKG. OF 10)
LIST NO. 52600-04	TIP ONLY, FENESTRATED GRASPER- STERILE (PKG. OF 10)
LIST NO. 52600-05	TIP ONLY, ENDO-CLINCH GRASPER-STERILE (PKG. OF 10)

### MONOPOLAR ATRAUMATIC TISSUE GRASPER / VESSEL SEALER



**Features:**

- Completely reusable, fully autoclavable
- Monopolar 3-piece take a part for the most effective cleaning
- Heavy duty shaft insulation
- Lightweight ergonomic carbon fiber handle with selective on/off ratchet
- Atraumatic sure grip jaw

LIST NO. 52255-103C7	5MM DIA. 33CM ATRAUMATIC TISSUE GRASPER / VESSEL SEALER
LIST NO. 52155-103C7	5MM DIA. 45CM ATRAUMATIC TISSUE GRASPER / VESSEL SEALER

We offer complete solution for Electrosurgical Accessories for hospital at the right price.

The Ultimate Laparoscopic Instrument for Retraction of Myomas, Fibroids, Ovaries & Other Organs



LIST NO. 52505-52	3-PRONG BULLDOG HASSON GRASPER 32 CM LONG 5 MM Ø AGGRESSIVE JAWS.
LIST NO. 52515-52	3 PRONG BULLDOG HASSON GRASPER 45 CM LONG 5 MM Ø AGGRESSIVE JAWS.

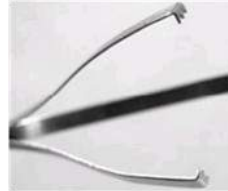

LIST NO. 52505-53	3-PRONG BULLDOG HASSON GRASPER 32 CM LONG 5 MM Ø CURVED ALLIS TEETH
LIST NO. 52515-53	3 PRONG BULLDOG HASSON GRASPER 45 CM LONG 5 MM Ø CURVED ALLIS TEETH

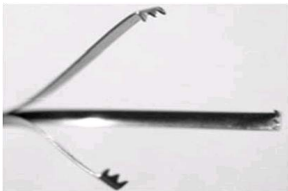

LIST NO. 52505-54	3-PRONG BULLDOG HASSON GRASPER 32 CM LONG 5 MM Ø STRAIGHT ALLIS TEETH
LIST NO. 52515-54	3 PRONG BULLDOG HASSON GRASPER 45 CM LONG 5 MM Ø STRAIGHT ALLIS TEETH

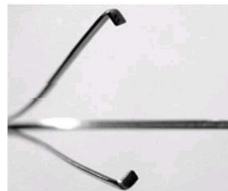

LIST NO. 52505-55	3-PRONG BULLDOG HASSON GRASPER 32 CM LONG 5 MM Ø BLUNT EDGED JAWS
LIST NO. 52515-55	3 PRONG BULLDOG HASSON GRASPER 45 CM LONG 5 MM Ø BLUNT EDGED JAWS

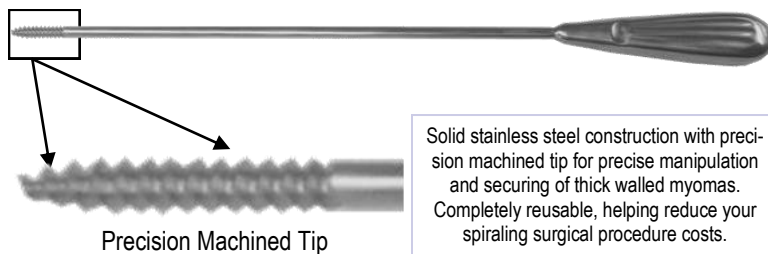

Solid stainless steel construction with precision machined tip for precise manipulation and securing of thick walled myomas. Completely reusable, helping reduce your spiraling surgical procedure costs.

LIST NO. 52505-98	5mm Ø, 33cm working length Myoma screw
LIST NO. 52515-98	3 5mm Ø, 45cm working length Myoma screw
LIST NO. 52505-99	10mm Ø, 33cm working length Myoma screw
LIST NO. 52515-99	10mm Ø, 45cm working length Myoma screw

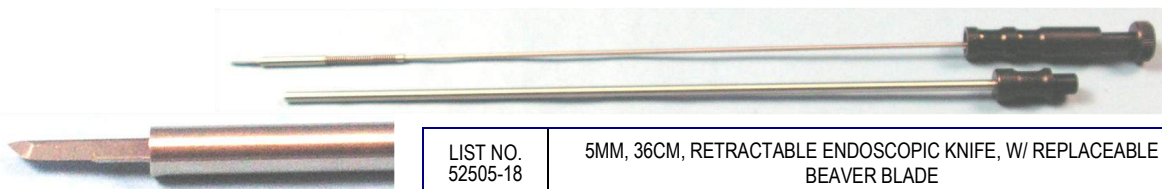

LIST NO. 52505-18	5MM, 36CM, RETRACTABLE ENDOSCOPIC KNIFE, W/ REPLACEABLE BEAVER BLADE
----------------------	--

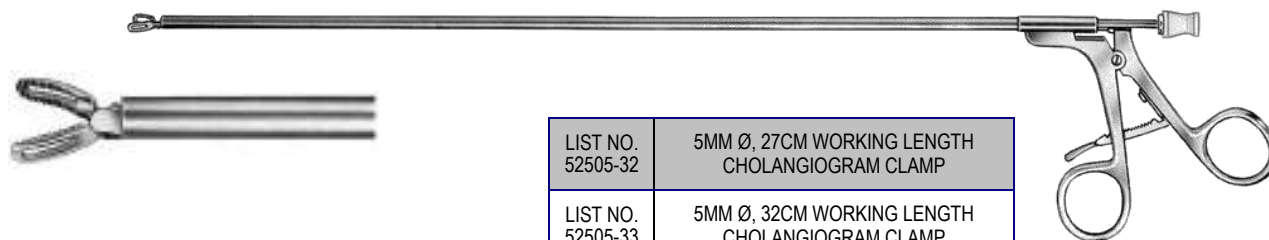

All 5mm Diameter,  
4 Different Working Lengths

LIST NO. 52505-32	5MM Ø, 27CM WORKING LENGTH CHOLANGIOGRAM CLAMP
LIST NO. 52505-33	5MM Ø, 32CM WORKING LENGTH CHOLANGIOGRAM CLAMP
LIST NO. 52505-34	5MM Ø, 36CM WORKING LENGTH CHOLANGIOGRAM CLAMP
LIST NO. 52505-35	5MM Ø, 45CM WORKING LENGTH CHOLANGIOGRAM CLAMP

Stainless Steel Construction With Serrated Handle for Precise Grip  
\*\*\*Important: Instrument to be used ONLY under direct vision\*\*\*



LIST NO. 52805-01	5MM Ø, 33CM LAPAROSCOPIC MAGNETIC ROD	LIST NO. 52810-01	10MM Ø, 33CM LAPAROSCOPIC MAGNETIC ROD
LIST NO. 52805-02	5MM Ø, 45CM LAPAROSCOPIC MAGNETIC ROD	LIST NO. 52810-02	10MM Ø, 45CM LAPAROSCOPIC MAGNETIC ROD
LIST NO. 52803-01	3MM Ø, 33CM LAPAROSCOPIC MAGNETIC ROD		
LIST NO. 52803-02	3MM Ø, 45CM LAPAROSCOPIC MAGNETIC ROD		



LIST NO. 52103-19	3MM, 45CM INJECTION, ASPIRATION, & BIOPSY NEEDLE
LIST NO. 52803-02	5MM, 45CM ASPIRATION NEEDLE, 15 GA. NEEDLE SIZE - STANDARD (18 GA TO 25 GA AVAILABLE - PLEASE SPECIFY)
LIST NO. 52105-27R	5MM, 45CM RETRACTABLE ASPIRATION NEEDLE, 15 GA. NEEDLE SIZE - STANDARD (18 GA. TO 25 GA. AVAILABLE - PLEASE SPECIFY)
LIST NO. 52105-27W	5MM DIA., 45CM ASPIRATION NEEDLE, WITH ANGLED 45 DEGREE TUBE, 15 GA. NEEDLE SIZE - STANDARD (18 GA. TO 25 GA. AVAILABLE - PLEASE SPECIFY)
LIST NO. 52203-22	3MM DIA., 33CM INJECTION, ASPIRATION AND BIOPSY NEEDLE
LIST NO. 52205-31	5MM DIA., 33CM ASPIRATION NEEDLE 15 GA. NEEDLE SIZE - STANDARD (18 GA. TO 25 GA. AVAILABLE - PLEASE SPECIFY)
LIST NO. 52205-31R	5MM DIA., 33CM RETRACTABLE ASPIRATION NEEDLE 15 GA. NEEDLE SIZE - STANDARD (18 GA. TO 25 GA. AVAILABLE - PLEASE SPECIFY)

We offer complete solution for Electrosurgical Accessories for hospital at the right price.



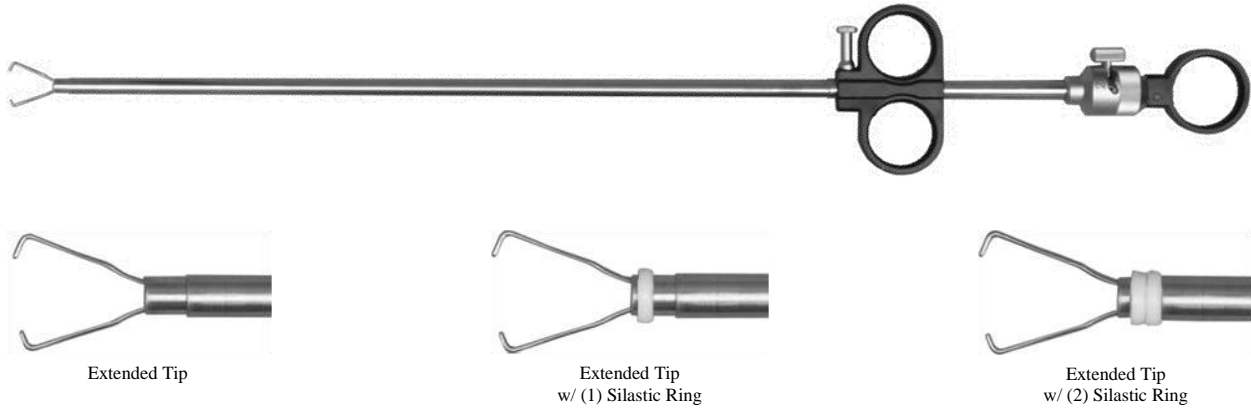

LIST NO. 52105-500	6MM Ø, 40CM SILASTIC RING APPLICATOR- FOR SINGLE AND DUAL RING APPLICATION; USE WITH OPERATING LAPAROSCOPE WITH 6MM Ø INSTRUMENT CHANNEL (SUGGEST Darters LIST NO. 52110-06).
LIST NO. 52205-501	6 MM Ø, 33 CM SILASTIC RING APPLICATOR FOR SINGLE AND DUAL RING APPLICATION; USE WITH LAPAROSCOPE AND 6MM Ø TROCAR SLEEVE (SEE Darters DATA SHEET FOR APPROPRIATE SLEEVE).
LIST NO. 52208-501	8 MM Ø, 27 CM SILASTIC RING APPLICATOR- FOR SINGLE AND DUAL RING APPLICATION; USE WITH LAPAROSCOPE AND 8MM Ø TROCAR SLEEVE (SEE Darters DATA SHEET FOR APPROPRIATE SLEEVE). SAME DIAMETER AS ACMI
LIST NO. 52208-501	8 MM Ø, 33 CM SILASTIC RING APPLICATOR- FOR SINGLE AND DUAL RING APPLICATION; USE WITH LAPAROSCOPE AND 8MM Ø TROCAR SLEEVE (SEE Darters DATA SHEET FOR APPROPRIATE SLEEVE). SAME DIAMETER AS ACMI
LIST NO. 52005-500	SILASTIC RING (PACKAGE OF 10) FOR TUBAL LIGATION NON-STERILE, AUTOCLAVABLE
LIST NO. 52005-501	SILASTIC RING APPLIER AND GUIDE CONE SET (NOTE: (1) SET COMES WITH NEW INSTRUMENT)

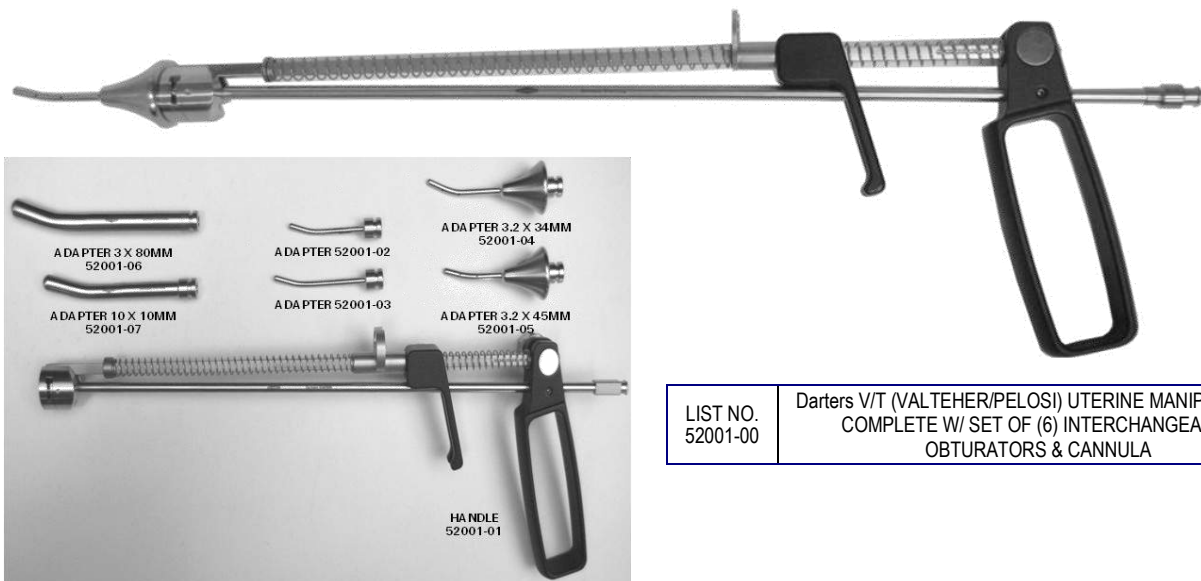

LIST NO. 52001-00	Darters V/T (VALTEHER/PELOS) UTERINE MANIPULATOR: COMPLETE W/ SET OF (6) INTERCHANGEABLE OBTURATORS & CANNULA
----------------------	---

We offer complete solution for Electrosurgical Accessories for hospital at the right price.



LIST NO. 52001-13	COHEN CANNULA 2/ LARGE/SMALL REPLACEABLE TIPS
LIST NO. 52001-19L	REPLACEMENT ACORN, LARGE, FOR 52001-13
LIST NO. 52001-19S	REPLACEMENT ACORN, SMALL, FOR 52001-13
LIST NO. 52001-14	COHEN CANNULA WITH LARGE/SMALL REPLACABLE TIPS- SLOTTED HANDLE
LIST NO. 52001-29	3MM CLEANING BRUSH FOR FRONT TUBE OF COHEN CANNULA (QTY 12/PACK)
LIST NO. 52001-31	5MM CLEANING BRUSH FOR REAR TUBE OF COHEN CANNULA (QTY 12/PACK)



LIST NO. 52001-12S	COHEN CANNULA WITH FIXED SMALL STAINLESS STEEL ACORN
LIST NO. 52001-12L	COHEN CANNULA WITH FIXED LARGE STAINLESS STEEL ACORN
LIST NO. 52001-29	3MM CLEANING BRUSH FOR FRONT TUBE OF COHEN CANNULA (QTY 12/PACK)
LIST NO. 52001-31	5MM CLEANING BRUSH FOR REAR TUBE OF COHEN CANNULA (QTY 12/PACK)



LIST NO. 52001-24	PALPATION PROBE, ROUND ENDS, 5MM DIA., 50CM LONG
LIST NO. 52001-25	PALPATION PROBE ROUND ENDS, 10MM DIA., 50CM LONG
LIST NO. 52001-26	PALPATION PROBE, ROUND ENDS, 10MM DIA., 33CM LONG

Multiple Lengths Available.  
Please inquire when placing your order

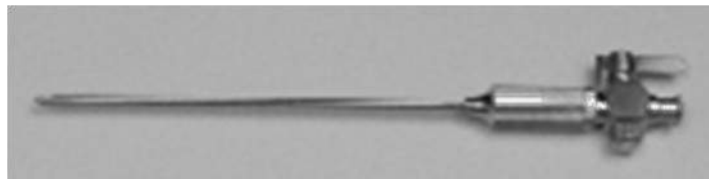

LIST NO. 52003-07	2 MM DIA., 260 MM (10") VERESS INSUFLATION NEEDLE
LIST NO. 52003-08	2 MM DIA., 180 MM (7") VERESS INSUFLATION NEEDLE
LIST NO. 52003-09	2 MM DIA., 55 MM (2") VERESS INSUFLATION NEEDLE

LIST NO. 52003-10	2 MM DIA., 100 MM (4") VERESS INSUFLATION NEEDLE
LIST NO. 52003-11	2 MM DIA., 120 MM (5") VERESS INSUFLATION NEEDLE
LIST NO. 52003-12	2 MM DIA., 150 MM (6") VERESS INSUFLATION NEEDLE

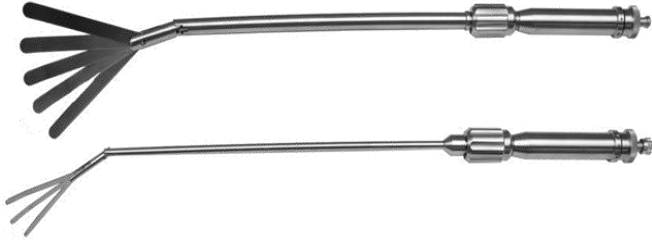

LIST NO. 52505-15	5 MM Ø, 34 CM ARTICULATING FAN RETRACTOR RETRACTOR / ELEVATOR WITH 3 FLAT, 60 DEGREE ARTICULATING AND FOLDING BLADES, (60 MM MAX WIDTH), ADJUSTABLE HANDLE WITH FLUSHPORT, STAINLESS STEEL
LIST NO. 52510-15	10 MM Ø, 34 CM ARTICULATING FAN RETRACTOR RETRACTOR / ELEVATOR WITH 5 FLAT, 60 DEGREE ARTICULATING AND FOLDING BLADES, (90 MM MAX WIDTH), ADJUSTABLE HANDLE WITH FLUSHPORT, STAINLESS STEEL
LIST NO. 52525-15	5 MM Ø, 45 CM ARTICULATING FAN RETRACTOR RETRACTOR / ELEVATOR WITH 3 FLAT, 60 DEGREE ARTICULATING AND FOLDING BLADES, (60 MM MAX WIDTH), ADJUSTABLE HANDLE WITH FLUSHPORT, STAINLESS STEEL
LIST NO. 52515-15	10 MM Ø, 45 CM ARTICULATING FAN RETRACTOR RETRACTOR / ELEVATOR WITH 5 FLAT, 60 DEGREE ARTICULATING AND FOLDING BLADES, (90 MM MAX WIDTH), ADJUSTABLE HANDLE WITH FLUSHPORT, STAINLESS STEEL

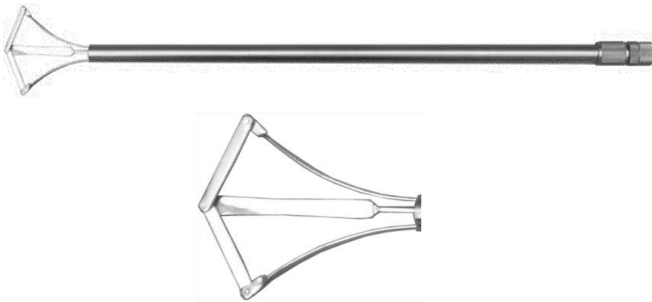

LIST NO. 52505-50	5 MM Ø, 33 CM RETRACTOR/ELEVATOR CURVED, ROTATABLE, TRIANGULAR KITE-SHAPED BLADE, LOCKING HANDLE
LIST NO. 52515-50	5 MM Ø, 45 CM RETRACTOR/ELEVATOR CURVED, ROTATABLE, TRIANGULAR KITE-SHAPED BLADE, LOCKING HANDLE
LIST NO. 52505-51	5 MM Ø, 33 CM RETRACTOR/ELEVATOR STRAIGHT, ROTATABLE, TRIANGULAR KITE-SHAPED BLADE, LOCKING HANDLE
LIST NO. 52515-51	5 MM Ø, 45 CM RETRACTOR/ELEVATOR STRAIGHT, ROTATABLE, TRIANGULAR KITE-SHAPED BLADE, LOCKING HANDLE
LIST NO. 52510-50	5 MM Ø, 45 CM RETRACTOR/ELEVATOR CURVED, ROTATABLE, TRIANGULAR KITE-SHAPED BLADE, LOCKING HANDLE
LIST NO. 52511-50	10 MM Ø, 45 CM RETRACTOR/ELEVATOR STRAIGHT, ROTATABLE, TRIANGULAR KITE-SHAPED BLADE, LOCKING HANDLE



LIST NO. 52505-40	5 MM Ø, 33 CM RETRACTOR/ELEVATOR 90 DEGREE ARTICULATING TEFLON TIP, ACCORDING TO DR. VALLE, WITH FLUSH
LIST NO. 52505-51	5 MM Ø, 33 CM ELEVATOR/PROBE STRAIGHT, TEFLON TIP, ACCORDING TO DR. VALLE



LIST NO. 52505-39	5 MM Ø, 33 CM LEVER/ELEVATOR RETRACTABLE, STRAIGHT, 4-FINGER BLADES, ROTATABLE INSERT
LIST NO. 52515-39	5 MM Ø, 45 CM LEVER/ELEVATOR RETRACTABLE, STRAIGHT, 4-FINGER BLADES, ROTATABLE INSERT

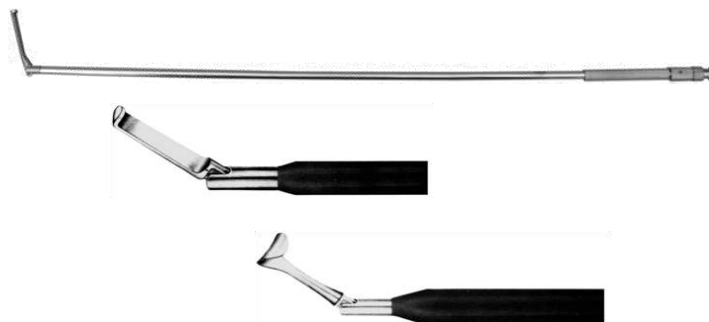

LIST NO. 52505-48	5 MM Ø, 33 CM RETRACTOR; 90 DEGREE ARTICULATING FLAT BLADE, WITH FLUSH PORT
LIST NO. 52515-48	5 MM Ø, 45 CM RETRACTOR; 90 DEGREE ARTICULATING FLAT BLADE, WITH FLUSH PORT
LIST NO. 52510-87	10 MM Ø, 33 CM RETRACTOR; 90 DEGREE ARTICULATING FLAT BLADE, WITH FLUSH PORT
LIST NO. 52511-87	10 MM Ø, 45 CM RETRACTOR; 90 DEGREE ARTICULATING FLAT BLADE, WITH FLUSH PORT
LIST NO. 52510-86	10 MM Ø, 33 CM RETRACTOR; 90 DEGREE ARTICULATING "CUSHING"-TYPE BLADE, WITH FLUSH PORT
LIST NO. 52511-86	10 MM Ø, 45 CM RETRACTOR; 90 DEGREE ARTICULATING "CUSHING"-TYPE BLADE, WITH FLUSH PORT



LIST NO. 52525-21	5 MM DIA., 36 CM, ESOPHAGEAL RETRACTOR FOR APPLICATION GASTRIC BANDING 90 DEGREE ARTICULATING
LIST NO. 52515-21	10 MM DIA., 36 CM, ESOPHAGEAL RETRACTOR FOR APPLICATION GASTRIC BANDING 90 DEGREE ARTICULATING DISTAL TIP, FLUSH PORT
LIST NO. 52525-30	5MM DIA., 41CM, ESOPHAGEAL RETRACTOR FOR APPLICATION GASTRIC BANDING 90 DEGREE ARTICULATING
LIST NO. 52515-30	10MM DIA., 41CM, ESOPHAGEAL RETRACTOR WITH ARTICULATING CONTROL KNOB ON HANDLE, WITH FLUSHPORT



LIST NO. 52525-21B4	5MM DIA., 34CM ARTICULATING RETRACTOR FOR LAP BAND-RING HANDLE W/ RATCHET, ROTATING-ONE PIECE W/FLUSH PORT
LIST NO. 52515-21B4	10 MM DIA., 34 CM ARTICULATING RETRACTOR FOR LAP BAND-RING HANDLE W/ RATCHET, ROTATING-ONE PIECE W/FLUSH PORT
52525-30B4	5MM DIA., 41CM, ESOPHAGEAL RETRACTOR-GASTRIC BAND MANIPULATOR 90 DEG. ANGULATION WITH RING RATCHET HANDLE RIGID - ONE PIECE WITH FLUSH PORT
52515-30B4	10MM DIA., 41CM, ESOPHAGEAL RETRACTOR-GASTRIC BAND MANIPULATOR, 90 DEG., ANGULATION, WITH RING RATCHET HANDLE, ROTATABLE- ONE PIECE W/FLUSH PORT



LIST NO. 52550-07	5MM, 40CM LAPAROSCOPIC RETRACTOR W/ FLEXIBLE, RIGHT ANGLED, FORMABLE TIP
-------------------	--



LIST NO. 52550-05	5 MM DIA., 40 CM, LAPAROSCOPIC RETRACTOR W/ FLEXIBLE TRIANGULAR FORMABLE TIP
-------------------	--



LIST NO. 52550-06	5MM, 40CM LAPAROSCOPIC RETRACTOR W/ FLEXIBLE TRIANGULAR, RIGHT ANGLED FORMABLE TIP
-------------------	--

We offer complete solution for Electrosurgical Accessories for hospital at the right price.

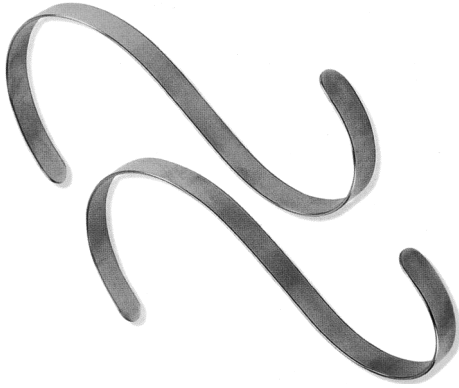

Custom Widths Available...Please Specify When Ordering

LIST NO. 52110-98	HASSON S-SHAPED RETRACTOR, 3/8" BLADE WIDTH, SET OF 2
LIST NO. 52110-97	HASSON S-SHAPED RETRACTOR, 1/2" BLADE WIDTH, SET OF 2
LIST NO. 52110-96	HASSON S-SHAPED RETRACTOR, 3/4" BLADE WIDTH, SET OF 2
LIST NO. 52110-95	HASSON S-SHAPED RETRACTOR, 1" BLADE WIDTH, SET OF 2

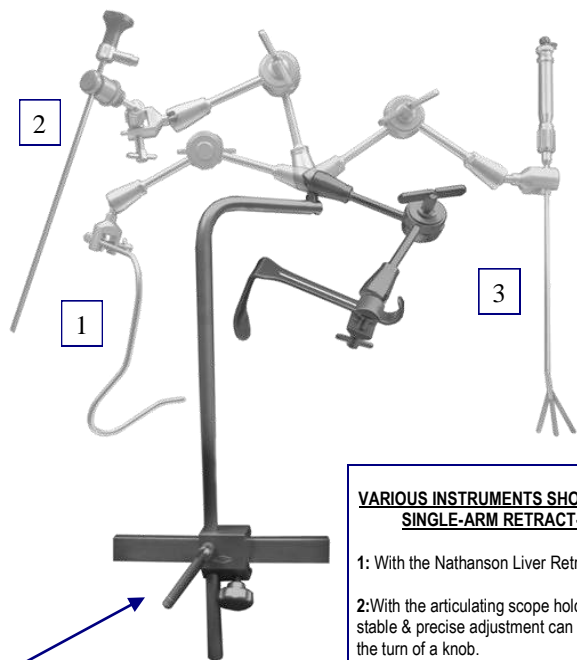

**VARIOUS INSTRUMENTS SHOWN WITH THE SINGLE-ARM RETRACT-ROBOT:**

- 1: With the Nathanson Liver Retractor
- 2: With the articulating scope holder: quick, stable & precise adjustment can be made with the turn of a knob.
- 3: With the Fan Retractor; any type of retractor can be held in a stable, fully adjustable position at maximum retraction, e.g. flat, round, etc.

**The Darters Steril-Clamp:**  
Provide safe and stable mounting in sterile condition on top of the drape or any operating table rail

LIST NO. 15088-00	Darters RETRACT-ROBOT SINGLE ARM INSTRUMENT
LIST NO. 15088-01	Darters RETRACT-ROBOT SINGLE ARM INSTRUMENT W/ EXTRA-LONG MOUNTING ROD (26") (BARIATRIC)
LIST NO. 15090-53	Darters STERIL-CLAMP HEAVY DUTY, 5/8" ROUND HOLE OR 1/2" X 1" SLOT (FOR EXTRA LONG ROBOT ARM)
LIST NO. 15090-56	Darters STERIL-CLAMP STANDARD, AUTOCLAVABLE W/ ROUND 5/8" ACCESSORY OPENING
LIST NO. 15090-57	Darters EXTENSION CLAMP FOR BARIATRIC SURGERY: AUTOCLAVABLE, 5/8" ACCESSORY OPENING
LIST NO. 52410-01	Darters SCOPE/INSTRUMENT HOLDER W/ ARTICULATION JOINT SELF-RETAINING CLAMP (SLEEVE STYLE)
LIST NO. 52400-00	Darters ENODOSCOPIC FIXATION DEVICE CONSISTING OF: LIST NO.'S: 15088-00, 15090-56, & 52410-01
LIST NO. 52400-01	Darters BARIATRIC ENODOSCOPIC FIXATION DEVICE CONSISTING OF LIST NO.'S: 15088-01, 15090-53, & 52410-01



Darters EXTENSION CLAMP FOR BARIATRIC SURGERY (FITS INTO STERIL-CLAMP)



**Features of the Goose-Neck System:**

- All components are made of a high grade stainless steel.
- The complete system, including the Steril-Clamp™, may be flash auto-claved
- The self-retaining joints rotate & twist in every desirable position
- The instrument shaft fits into table accessory clamps such as those used for stirrups & leg holders, as well as all of the other over-the-drape clamps with an opening of 5/8"
- The vertical shaft (5/8") may be lowered or heightened within the clamp for flexible adjustment
- Two different models with different instrument holders available

LIST NO. 15090-61	Darters GOOSE-NECK RETRACTOR SYSTEM WITH SELF-RETAINING SLEEVE CLAP WITH ARTICULATING JOINT FOR HOLDING TELESCOPES INCLUDES 15090-56: STERIL-CLAMP™ FOR ATTACHING TO TABLE
LIST NO. 15090-60	Darters GOOSE-NECK RETRACTOR SYSTEM WITH UNIVERSAL MOUNTING CLAMP FOR HOLDING ALL TYPES OF INSTRUMENTS INCLUDES 15090-56: STERIL-CLAMP™ FOR ATTACHING TO TABLE

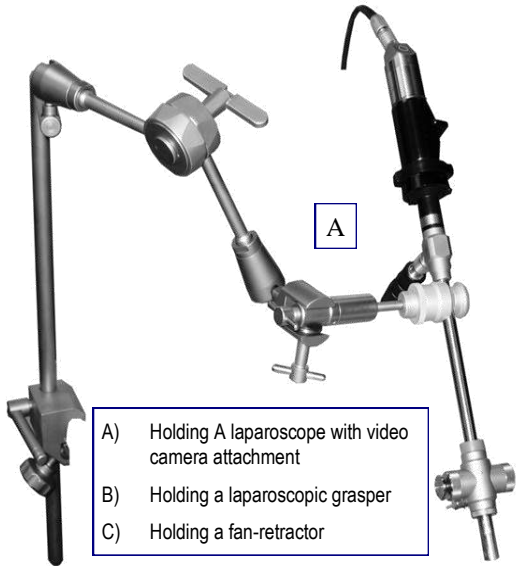

- A) Holding A laparoscope with video camera attachment
- B) Holding a laparoscopic grasper
- C) Holding a fan-retractor

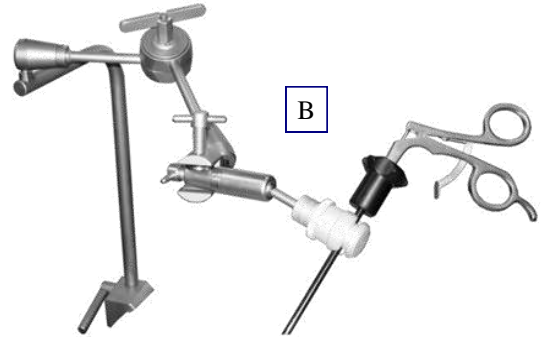

LIST NO. 52400-00	Darters ENDOSCOPE FIXATION DEVICE™ CONSISTING OF: (1) Darters STERIL-CLAMP, (1) Darters RETRACT-ROBOT, (1) SCOPE/INSTRUM HOLDER
----------------------	--



LIST NO. 52410-01	Darters McLUCAS SCOPE/INSTRUMENT HOLDER W/ ARTICULATION JOINT & QUICK-RELEASE SOFT- ALLOY SELF-RETAINING CLAMP
----------------------	--

LIST NO. 55040-02	Darters ALUMINUM STORAGE/STERILIZATION CONTAINER w/ PERFO- RATED LID & BOTTOM, w/ BRACKETS FOR MOUNTING RETRACT-ROBO #15088-01 or 15088-03 & STERIL CLAMP #15090-53 or 15090-56. (FOR WRAPPING.) DIMENSIONS: 30"L x 10"W x 6"H (76CM x 25CM x 15CM).
----------------------	---



**SYRINGE-TYPE KLEPPINGER BIPOLAR FORCEPS**

5MM DIAMETER, 32CM LENGTH		5MM DIAMETER, 45CM LENGTH	
LIST NO.	DESCRIPTION	LIST NO.	DESCRIPTION
52205-100	FLAT TIP	52105-100	FLAT TIP
52205-100S	STANDARD TIP	52105-100S	STANDARD TIP
52205-100T	FENESTRATED TIP	52105-100T	FENESTRATED TIP
52205-100M	MICRO TIP	52105-100M	MICRO TIP

*Bipolar Cables For Use With Kleppinger Forceps*



Darters / WOLF KLEPPINGER PLUG & DUAL-BANANA GENERATOR PLUG

LIST NO. 52005-24

**OR**



Darters / WOLF KLEPPINGER PLUG & Darters / WOLF GENERATOR PLUG

LIST NO. 52005-23

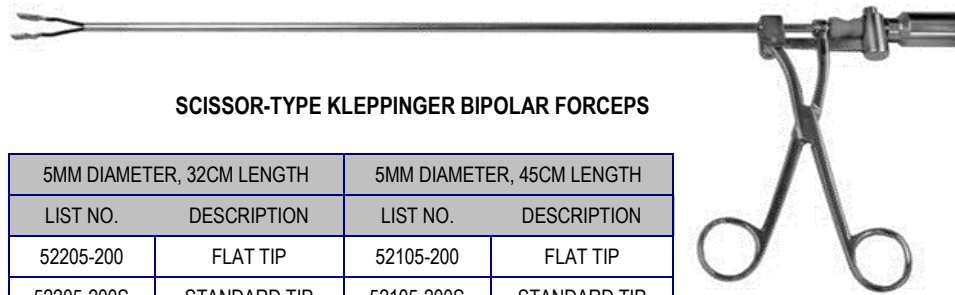

**SCISSOR-TYPE KLEPPINGER BIPOLAR FORCEPS**

5MM DIAMETER, 32CM LENGTH		5MM DIAMETER, 45CM LENGTH	
LIST NO.	DESCRIPTION	LIST NO.	DESCRIPTION
52205-200	FLAT TIP	52105-200	FLAT TIP
52205-200S	STANDARD TIP	52105-200S	STANDARD TIP
52205-200T	FENESTRATED TIP	52105-200T	FENESTRATED TIP
52205-200M	MICRO TIP	52105-200M	MICRO TIP

All of our inner tongs are interchangeable with the original Wolf style

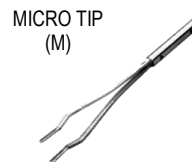
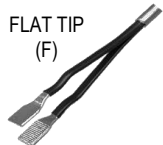

LIST NO.	DESCRIPTION
52205-101	32 CM - FLAT TIP (ORIGINAL KLEPPINGER) INNER TONG - F
52105-101	45 CM - FLAT TIP (ORIGINAL KLEPPINGER) INNER TONG - F
52205-102	32 CM - STANDARD TIP (FENESTRATED WITH WIRE) - INNER TONG - S
52105-102	45 CM - STANDARD TIP (FENESTRATED WITH WIRE) - INNER TONG - S
52205-103	32 CM - MICRO TIP (NARROW SHORT TIP) - INNER TONG - M
52105-103	45 CM - MICRO TIP (NARROW SHORT TIP) - INNER TONG - M
52205-104	32 CM - FENESTRATED TIP (FENESTRATED WITH TOOTH) - INNER TONG - T
52105-104	45 CM - FENESTRATED TIP (FENESTRATED WITH TOOTH) - INNER TONG - T

**Note:** Both the syringe and scissor handle Kleppinger forceps are available with the optional inner tongs. Use the first number from above for the instrument and add the letter of your choice for the optional insert S, T, M.

We also have reusable replacement tongs available for Storz, ACMI, Pilling and other brands of bipolar laparoscopic forceps



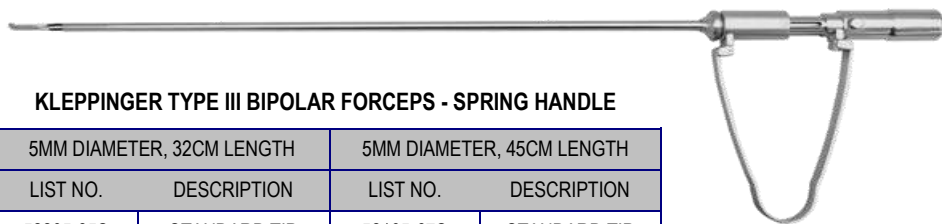

**KLEPPINGER TYPE III BIPOLAR FORCEPS - SPRING HANDLE**

5MM DIAMETER, 32CM LENGTH		5MM DIAMETER, 45CM LENGTH	
LIST NO.	DESCRIPTION	LIST NO.	DESCRIPTION
52205-85S	STANDARD TIP	52105-67S	STANDARD TIP
52205-85F	FLAT TIP	52105-67F	FLAT TIP
52205-85M	MICRO TIP	52105-64M	MICRO TIP

**Features:**

- Micro Polished Tip
- Stationary Inner Tong - it does not move in & out while opening & closing, giving the surgeon complete control of placement
- New type of cable connector for easier cleaning of handle & positive connection
- Interchangeable inner tongs
- Pressure-loaded mechanism of the spring handle assists in closing of the Instrument



**KLEPPINGER TYPE III BIPOLAR FORCEPS - SYRINGE STYLE**

5MM DIAMETER, 32CM LENGTH		5MM DIAMETER, 45CM LENGTH	
LIST NO.	DESCRIPTION	LIST NO.	DESCRIPTION
52205-96S	STANDARD TIP	52105-68S	STANDARD TIP
52205-96F	FLAT TIP	52105-68F	FLAT TIP
52205-96M	MICRO TIP	52105-68M	MICRO TIP

**Features:**

- Micro Polished Tip
- Stationary Inner Tong
- Interchangeable inner tongs
- Jaws close with closing of hand action, giving the surgeon complete control of how much pressure is exerted on the tissue



**KLEPPINGER TYPE III BIPOLAR FORCEPS - SPRING HANDLE W/ IRRIGATION**

5MM DIAMETER, 32CM LENGTH		5MM DIAMETER, 45CM LENGTH	
LIST NO.	DESCRIPTION	LIST NO.	DESCRIPTION
52205-96S	STANDARD TIP	52105-68S	STANDARD TIP
52205-96F	FLAT TIP	52105-68F	FLAT TIP
52205-96M	MICRO TIP	52105-68M	MICRO TIP

**Features:**

- Irrigation capability to prevent the jaws from sticking to the same tissue from sticking to the during coagulation
- Flow of irrigation fluid controlled through trumpet valve or luer fitting (select as needed)

Bipolar Cables For Use With Darters Type III

Kleppinger Forceps



Darters TYPE III KLEPPINGER PLUG & DUAL-BANANA GENERATOR PLUG

LIST NO. 52005-20

**OR**



Darters TYPE III KLEPPINGER PLUG & Darters / WOLF GENERATOR PLUG

LIST NO. 52005-23



**KLEPPINGER TYPE II BIPOLAR FORCEPS - SLIDE HANDLE**

5MM DIAMETER, 32CM LENGTH		5MM DIAMETER, 45CM LENGTH	
LIST NO.	DESCRIPTION	LIST NO.	DESCRIPTION
52205-43S	STANDARD TIP	52105-64S	STANDARD TIP
52205-43F	FLAT TIP	52105-64F	FLAT TIP
52205-43M	MICRO TIP	52105-64M	MICRO TIP

**Features:**

- Micro Polished Tip
- Stationary Inner Tong
- Interchangeable inner tongs
- Opening & closing of the jaw is controlled by sliding the handle back & forward, giving the surgeon complete control of how much pressure is exerted on the tissue

*Bipolar Cables For Use With Darters Type II*

*Kleppinger Forceps*



Darters TYPE II KLEPPINGER PLUG & DUAL-BANANA GENERATOR PLUG

LIST NO. 52005-22

**OR**



Darters TYPE II KLEPPINGER PLUG & Darters / WOLF GENERATOR PLUG

LIST NO. 52005-21



**Darters CLASSIC BIPOLAR FORCEPS - SLIDE HANDLE**

5MM DIAMETER, 32CM LENGTH		5MM DIAMETER, 45CM LENGTH	
LIST NO.	DESCRIPTION	LIST NO.	DESCRIPTION
52205-50	MICRO JAW	52105-37	MICRO JAW
52205-41	HOOK JAW	52105-38	HOOK JAW

**Features:**

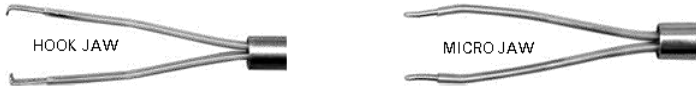

FLAT TIP (F)



STANDARD TIP (S)



MICRO TIP (M)



STANDARD TIP FOR SECURE SLIP-FREE GRIP		FLAT TIP, CONVENTIONAL KLEPPINGER STYLE		MICRO TIP FOR PRECISE, PIN-POINT COAGULATION	
32CM	45CM	32CM	45CM	32CM	45CM
52205-44	52105-70	52205-91	52105-71	52205-47	52105-72

**Note:**

When ordering replacement tongs for Darters Slid Handle Bipolar Forceps with a single tube or with irrigation tube, add letters "ST" to the above List Numbers (the price remains the same). For hand replacement parts for all Darters Laparoscopic Bipolar Forceps refer to the operating instructions.



*Bipolar Cables For Use With Darters Bipolar Powergrip Forceps & Scissors*



Darters TYPE II KLEPPINGER PLUG & DUAL-BANANA GENERATOR PLUG
LIST NO. 52005-22

**OR**



Darters TYPE II KLEPPINGER PLUG & Darters / WOLF GENERATOR PLUG
LIST NO. 52005-21

*We offer complete solution for Electrosurgical Accessories for hospital at the right price.*

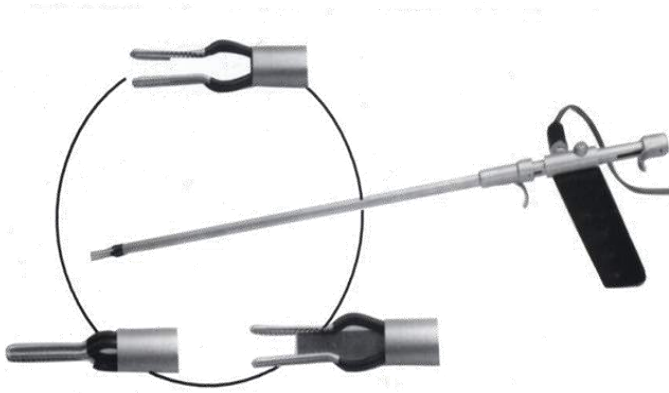

- Multiple Functions - Securely Grasp / Dissect Tissue / Safely Coagulate in the Bipolar Mode / Transect Tissue / Retract Tissue
- Reusability - easy, cost effective cleaning & maintenance
- Eliminating costly stapling devices
- One instrument, One insertion
- Reducing procedure time

*Bipolar Cables For Use With Darters Bipolar Triple Function Forceps*

LIST NO.	DESCRIPTION
52510-00	Darters BIPOLAR TRIPLE FUNCTION FORCEPS: 30 CM LONG, 10 MM
52510-00-01	COMPLETE INNER SHAFT ASSEMBLY WITH BLADE
52510-00-02	BLADE ASSEMBLY FOR TRIPLE FUNCTION FORCEPS

LIST NO.	DESCRIPTION
52005-80	BIPOLAR RF-CABLE FOR BIPOLAR TRIPLE FUNCTION FORCEPS AND Darters / WOLF GENERATORS
52005-81	BIPOLAR RF-CABLE FOR BIPOLAR TRIPLE FUNCTION FORCEPS AND MACHINE WITH TWO BANANA-PLUG CONNECTION

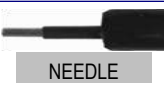
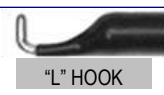
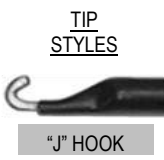

33CM	LIST NO. 52205-38
45CM	LIST NO. 52105-33
33CM	LIST NO. 52205-78
45CM	LIST NO. 52105-35
33CM	LIST NO. 52205-56
45CM	LIST NO. 52105-46
33CM	LIST NO. 52205-36
45CM	LIST NO. 52105-31
33CM	LIST NO. 52205-37
45CM	LIST NO. 52105-32
33CM	LIST NO. 52205-35
45CM	LIST NO. 52105-30
33CM	LIST NO. 52205-74
45CM	LIST NO. 52105-74

33CM	LIST NO. 52205-81
45CM	LIST NO. 52105-81
33CM	LIST NO. 52205-82
45CM	LIST NO. 52105-82
33CM	LIST NO. 52205-83
45CM	LIST NO. 52105-83
33CM	LIST NO. 52205-88
45CM	LIST NO. 52105-88
33CM	LIST NO. 52205-89
45CM	LIST NO. 52105-89
33CM	LIST NO. 52205-90
45CM	LIST NO. 52105-90
33CM	LIST NO. 52205-76
45CM	LIST NO. 52105-76

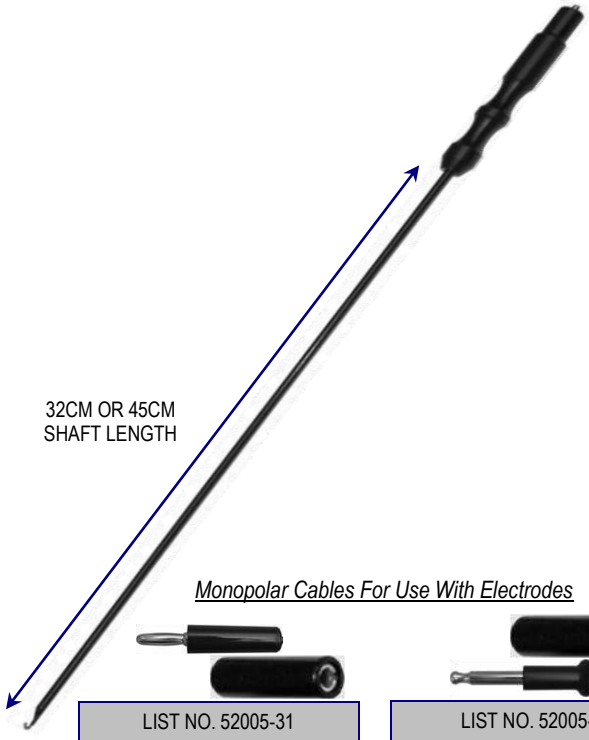

*Monopolar Cables For Use With Electrodes*

LIST NO. 52005-31	LIST NO. 52005-32
4MM DIA. PLUG (UNIT) & 4MM DIA. FEMALE INST. PLUG	8MM DIA. "BOVIE" PLUG (UNIT) & 4MM DIA. FEMALE INST. PLUG



		"J" HOOK	"L" HOOK	SPATULA	CONE	SLING	KNIFE	NEEDLE	SUCTION TIP
	33CM	LIST NO. 52205-57L	LIST NO. 52205-72L	LIST NO. 52205-58L	LIST NO. 52205-77L	LIST NO. 52205-66L	LIST NO. 52205-65L	LIST NO. 52205-74L	LIST NO. 52205-28L
	45CM	LIST NO. 52105-48L	LIST NO. 52105-56L	LIST NO. 52105-58L	LIST NO. 52105-58L	LIST NO. 52105-48L	LIST NO. 52105-47L	LIST NO. 52105-74L	LIST NO. 52105-28L
	33CM	LIST NO. 52205-57	LIST NO. 52205-72	LIST NO. 52205-58	LIST NO. 52205-77	LIST NO. 52205-66	LIST NO. 52205-65	LIST NO. 52205-74S	LIST NO. 52205-27
	45CM	LIST NO. 52105-48	LIST NO. 52105-56	LIST NO. 52105-58	LIST NO. 52105-58	LIST NO. 52105-48	LIST NO. 52105-47	LIST NO. 52105-74S	LIST NO. 52105-24
	33CM	LIST NO. 52205-63	LIST NO. 52205-73	LIST NO. 52205-64	LIST NO. 52205-84	LIST NO. 52205-68	LIST NO. 52205-67	LIST NO. 52205-74T	LIST NO. 52205-26
	45CM	LIST NO. 52105-54	LIST NO. 52105-57	LIST NO. 52105-50	LIST NO. 52105-60	LIST NO. 52105-52	LIST NO. 52105-51	LIST NO. 52105-74T	LIST NO. 52105-23

*We offer complete solution for Electrosurgical Accessories for hospital at the right price.*



"J" HOOK

33CM	LIST NO. 52850-81
45CM	LIST NO. 52815-81



"L" HOOK

33CM	LIST NO. 52850-82
45CM	LIST NO. 52815-82



SPATULA

33CM	LIST NO. 52850-83
45CM	LIST NO. 52815-83



CONE

33CM	LIST NO. 52850-84
45CM	LIST NO. 52815-84



BALL

33CM	LIST NO. 52850-85
45CM	LIST NO. 52815-85



KNIFE

33CM	LIST NO. 52850-86
45CM	LIST NO. 52815-86



NEEDLE

33CM	LIST NO. 52850-87
45CM	LIST NO. 52815-87



LIST NO.	DESCRIPTION
52505-17	5MM, 36CM, MONOPOLAR RETRACTABLE KNIFE, HOOK BLADE ELECTRODE, SIDE MOUNT RF POST



LIST NO. 52-5671	Darters LBC 50-P :BIPOLAR COAGULATOR WITH MUSICAL & VISUAL COAGULATION MONITOR & DIGITA INTENSITY SETTING, FEATURING SMART-O-MATIC™ & INTEGRITY TESTER. (INCLUDING WATER-SEALED FOOT-SWITCH.)
------------------	---

**OPTIONAL INSTRUMENT ENDS FOR BIPOLAR CABLES**

GENERATOR END



 STORZ FORCEPS NEW STYLE LIST NO. 52005-17	 Darters FORCEPS TYPE III LIST NO. 52005-19	 Darters FORCEPS LIST NO. 52005-21	 WOLF FORCEPS LIST NO. 52005-23
 STORZ FORCEPS LIST NO. 52005-25	 KLI / CIRCON 2-PIN FORCEPS LIST NO. 52005-39	 EVERST & CABOT FORCEPS LIST NO. 52005-41	 ALL TWIN PIN FORCEPS LIST NO. 52005-17
			 PILLING-LINVATEC FORCEPS LIST NO. 52005-17



**A MUST FOR SAFE FEMALE STERILIZATION**

LIST NO. 52-5675	Darters ARFM LAPAROSCOPIC BIPOLAR COAGULATION MONITOR FOR Darters OR WOLF GENERATORS
LIST NO. 52-5680	Darters ARFM LAPAROSCOPIC BIPOLAR COAGULATION MONITOR FOR VALLEYLAB, CONMED AND OTHER GENERATORS WITH TWO-BANANA PLUG CONNECTION



Endoscopic surgery has established itself as a standard procedure throughout the world. Since the technique significantly differs with open surgery, special electro-surgical generators are recommended.

**Darters** has been in the forefront of developing endoscopic instrumentation. Based on over 30 years of experience and collaborating with prominent surgeons we introduced a line of special electro-surgical generators for laparoscopy and minimal invasive procedures. These units meet and exceed all recommendations made by the Committee on Standards of the American Association of Gynecological Laparoscopists and Endoscopic Surgeons to the FDA and other recognized standards.

LIST NO. 52-5770M	<p align="center"><b><u>Darters ESU 100 E M/M:</u></b></p> <p>FOR LAPAROSCOPY AND OTHER MINIMALLY INVASIVE PROCEDURES. THIS UNIT FEATURES THE EXCLUSIVE Darters SMART-O-MATIC AUTOMATIC OUTPUT COMPENSATION CIRCUIT. IT HAS A MICRO/MACRO OUTPUT SELECTION SWITCH, MONOPOLAR OUTPUT SETTING BAR-GRAPH DISPLAY, SEPARATE MONOPOLAR AND BIPOLAR INTENSITY CONTROLS, BIPOLAR PRE-SELECT 20 WATT SWITCH AND MUSICAL BIPOLAR COAGULATION INDICATOR WITH BAR-GRAPH DISPLAY. (ACCESSORIES OPTIONAL, SELECT AS REQUIRED)</p>
----------------------	--



The **Darters ESU 100 E M/M-B** was specifically designed for laparoscopy and minimally invasive procedures where a sophisticated electro-surgical generator is required. The **ELME ESU 100 E M/M-B** is also suited for microsurgical requirements in gynecological endoscopy. This unit meets and exceeds all recommendations made by the Committee on Standards of the American Association of Gynecological Laparoscopists and Endoscopic Surgeons to the FDA and other recognized standards.

The **Darters ESU 100 E M/M-B** incorporates all of the well established features of the **ELEKTROTOM 120**, which is still used in over 3,000 hospitals throughout the United States.

LIST NO. 52-5771	<p align="center"><b><u>Darters ESU 100 E M/M-B:</u></b></p> <p>FOR LAPAROSCOPY &amp; OTHER MINIMALLY INVASIVE PROCEDURES. THIS UNIT FEATURES THE EXCLUSIVE Darters BI-POL CUTTER AND SMART-O-MATIC AUTOMATIC OUTPUT COMPENSATION CIRCUITS. IT HAS A MICRO/MACRO OUTPUT SELECTION SWITCH, MONOPOLAR OUTPUT SETTING BAR-GRAPH DISPLAY, SEPARATE MONOPOLAR AND BIPOLAR INTENSITY CONTROLS, BIPOLAR PRESELECT 20 WATT SWITCH AND MUSICAL BIPOLAR COAGULATION INDICATOR WITH BAR-GRAPH DISPLAY. (ACCESSORIES ARE OPTIONAL, SELECT AS REQUIRED)</p>
---------------------	--



**The Darters ESU 100 L M/M:**

-Is specifically designed for gynecological laparoscopy and pelviscopy where a sophisticated electro-surgical generator is required

-Is particularly suited for microsurgical requirements in gynecological endoscopy

-Meets and exceeds all recommendations of the Committee on Standards or the American Association of Gynecological Laparoscopists and other recognized standards.

LIST NO. 52-5795	<p align="center"><b><u>Darters ESU 100 L M/M</u></b> SPECIAL ELECTROSURGICAL UNIT FOR LAPAROSCOPY &amp; PELVISCOPY</p>
---------------------	---

The Darters ESU 100 L M/M is constructed as a table top unit. A special cart, List No. 52-5067, is available for this unit and other laparoscopic equipment





LIST NO. 5759	<b>Darters ESU 400 DIGITAL:</b> w/ SMART-MATIC CIRCUIT; MONOPOLAR AND BIPOLAR; RETURN ELECTRODE MONITOR (REM); COMPATIBLE WITH DUAL-CONTACT PATIENT PLATES
------------------	---

When safety, simplicity, service-free operation, along with economical pricing is your objective, the **ESU 400 DIGITAL** is the unit for you

**SUGGESTED OPTIONAL ACCESSORIES:**

LIST NO.	DESCRIPTION
5047	REUSABLE PATIENT PLATE
5071	CONNECTING CABLE FOR REUSABLE STAINLESS STEEL PATIENT PLATES (#5046 & 5047)
5044	RUBBER RETAINING STRAP FOR REUSABLE PATIENT PLATE
5395	SELF-ADHESIVE DISPOSABLE PATIENT PLATE (PKG. 25)
5702	PATIENT PLATE CONNECTING CABLE FOR DISPOSABLE PATIENT PLATE
5999	R.E.M. MODIFICATION W/ ADAPTER. INSTALL CIRCUIT FOR RETURN ELECTRODE MONITOR SYSTEM
4755	Darters EQUIPMENT TROLLEY WITH ONE DRAWER
5706	DOUBLE-PEDAL, EXPLOSION-PROOF FOOT-SWITCH (MONOPOLAR)
5709	DOUBLE-PEDAL, UL-APPROVED FOOT-SWITCH (MONOPOLAR)
5703	SINGLE-PEDAL, WATER-SEALED FOOT-SWITCH (BIPOLAR)
5707	SINGLE-PEDAL, UL-APPROVED FOOT-SWITCH (BIPOLAR)

**TECHNICAL DATA OF THE Darters ESU 400 DIGITAL:**

**OUTPUT POWER:**

**Generator I**, measured at 300 Ohm load  
 Non-modulated Sinusoidal Current 400 Watts  
 Modulated Blend I Current 150 Watts  
 Modulated Blend II Current 100 Watts

**Generator II**, measured at 300 Ohm load  
 Modulated, high voltage "coagulation" current 70 Watts

**Generator III**, measured at 100 Ohm load  
 Non-modulated, low voltage bipolar current 70 Watts

**Operating Frequency:** 500 KHz

**Dimensions:** 15.5"W x 12.5"D x 6"H (40CM W x 32CM D x 15CM H)

**Weight:** 14 lbs. (6.5 kg)

**Power Requirements:** 117 Volts, 60 Hz, 4 A  
 (Other power requirements upon request)

**Technical Data for Wattage, Voltage and Frequency:** ±20%

**Unit meets latest electrical safety standards of US 544, CSA, NFPA, and IEC proposed standards.**

*We offer complete solution for Electrosurgical Accessories for hospital at the right price.*



**GENERATOR END**

**INSTRUMENT END**



**GENERATOR END**

LIST NO. 5021	4MM DIA. PLUG (UNIT) & 4MM DIA. INST. PLUG		LIST NO. 5009	8MM DIA. "BOVIE" PLUG (UNIT) & 4MM DIA. INST. PLUG
LIST NO. 5022	4MM DIA. PLUG (UNIT) & OLSEN TYPE SCREW- ON INST. PLUG		LIST NO. 5023	8MM DIA. "BOVIE" PLUG (UNIT) & OLSEN TYPE SCREW-ON INST. PLUG
LIST NO. 5029	4MM DIA. PLUG (UNIT) & OLYMPUS TYPE INST. PLUG		LIST NO. 5030	8MM DIA. "BOVIE" PLUG (UNIT) & OLYMPUS TYPE INST. PLUG
LIST NO. 5260	4MM DIA. PLUG (UNIT) & ACMI TYPE INST. PLUG		LIST NO. 5261	8MM DIA. "BOVIE" PLUG (UNIT) & ACMI TYPE INST. PLUG
LIST NO. 5268	4MM DIA. PLUG (UNIT) & TAPERED "DOWNS" TYPE INST. PLUG		LIST NO. 5269	8MM DIA. "BOVIE" PLUG (UNIT) & TAPERED "DOWNS" TYPE PLUG
LIST NO. 52005-29	4MM DIA. PLUG (UNIT) & 3MM DIA. FEMALE INST. PLUG		LIST NO. 52005-30	8MM DIA. "BOVIE" PLUG (UNIT) & 3MM DIA. FEMALE INST. PLUG
LIST NO. 52005-31	4MM DIA. PLUG (UNIT) & 4MM DIA. FEMALE INST. PLUG		LIST NO. 52005-32	8MM DIA. "BOVIE" PLUG (UNIT) & 4MM DIA. FEMALE INST. PLUG
LIST NO. 52005-35	4MM DIA. PLUG (UNIT) & CORSON NEEDLE ELECTRODE INST. PLU		LIST NO. 52005-36	8MM DIA. "BOVIE" PLUG (UNIT) & CORSON NEEDLE ELECTRODE INST. PLUG
LIST NO. 52005-37	4MM DIA. PLUG (UNIT) & DUAL STAGE MALE (STORZ) INST. PLUG		LIST NO. 52005-38	8MM DIA. "BOVIE" PLUG (UNIT) & DUAL STAGE MALE (STORZ) INST. PLUG
LIST NO. 52005-47	4MM DIA. PLUG (UNIT) & RESECTOSCOPE INST. PLUG		LIST NO. 52005-48	8MM DIA. "BOVIE" PLUG (UNIT) & RESECTOSCOPE INST. PLUG
LIST NO. 52005-49	4MM DIA. PLUG (UNIT) & 4MM DIA. RECESSED PIN (WOLF/CORSON/STORZ) INST. PLUG		LIST NO. 52005-50	8MM DIA. "BOVIE" PLUG (UNIT) & 4MM DIA. RECESSED PIN (WOLF/CORSON/STORZ) INST.
LIST NO. 52005-69	4MM DIA. PLUG (UNIT) & 4MM DIA. SELF- RETAINING PLUG FOR STORZ SOLID POST INST.		LIST NO. 52005-70	8MM DIA. "BOVIE" PLUG (UNIT) & 4MM DIA. SELF- RETAINING PLUG FOR STORZ SOLID POST INST.
LIST NO. 52005-71	4MM DIA. PLUG (UNIT) & 4MM DIA. INSULATED OUTER SLEEVE PLUG FOR V.MUELLER INST		LIST NO. 52005-72	8MM "BOVIE" PLUG (UNIT) & 4MM INSULATED OUTER SLEEVE PLUG FOR V.MUELLER INST.
LIST NO. 52005-73	4MM DIA. EXTRA-LONG PLUG (UNIT) & 4MM DIA. EXTRA-LONG PLUG: STORZ INST.		LIST NO. 52005-74	8MM DIA. "BOVIE" PLUG (UNIT) & 4MM DIA. EXTRA-LONG PLUG: STORZ INST
LIST NO. 52005-75	4MM DIA. PLUG (UNIT) & 4MM DIA. RIGHT ANGLE FEMALE INST. PLU .		LIST NO. 52005-76	8MM DIA. "BOVIE" PLUG (UNIT) & 4MM DIA. RIGHT ANGLE FEMALE INST. PLUG
LIST NO. 52005-77	4MM DIA. PLUG (UNIT) & MALE LUER LOCK INST. PLUG		LIST NO. 52005-78	8MM DIA. "BOVIE" PLUG (UNIT) & MALE LUER LOCK INST. PLUG

**MONOPOLAR CABLE ADAPTERS**



LIST NO.  
5414

ADAPTER FOR MALE "BOVIE"  
GENERATOR PLUG & 4MM FE-  
MALE BANANA CABLE PLUG



LIST NO.  
5415

ADAPTER FOR MALE "BOVIE"  
GENERATOR PLUG & DISPOS-  
ABLE INSTRUMENT PLUG



LIST NO.  
5416

ADAPTER FOR MALE  
BANANA GENERATOR PLUG &  
DISPOSABLE INSTRUMENT PLUG



**GENERATOR END**

**INSTRUMENT END**



**GENERATOR END**

LIST NO. 52005-21 / 5302	Darters/WOLF PLUG (UNIT) & Darters (DIN) INSTRUMENT PLUG		LIST NO. 52005-22 / 5230	DUAL-BANANA PLUG (UNIT) & Darters (DIN) INSTRUMENT PLUG
LIST NO. 52005-19	Darters/WOLF PLUG (UNIT) & Darters TYPE III INST. PLUG		LIST NO. 52005-20	DUAL-BANANA PLUG (UNIT) & Darters TYPE III INST. PLUG
LIST NO. 52005-23	Darters/WOLF UNIT PLUG & WOLF INST. PLUG		LIST NO. 52005-24	DUAL-BANANA PLUG (UNIT) & WOLF INST. PLUG
LIST NO. 52005-25	Darters/WOLF PLUG (UNIT) & STORZ/WISAP/JARIT METAL INST. PLUG		LIST NO. 52005-26	DUAL-BANANA PLUG (UNIT) & STORZ/WISAP/JARIT METAL PLUG
LIST NO. 52005-17	Darters/WOLF PLUG (UNIT) & STORZ/WISAP BARREL STYLE INST. PLUG		LIST NO. 52005-18	DUAL-BANANA PLUG (UNIT) & STORZ/WISAP BARREL STYLE INST. PLUG
LIST NO. 52005-39	Darters/WOLF PLUG (UNIT) & KLI/CIRCON INST. PLUG		LIST NO. 52005-40	DUAL-BANANA PLUG (UNIT) & KLI/CIRCON INST. PLUG
LIST NO. 52005-41	Darters/WOLF PLUG (UNIT) & EVEREST/COBALT INST. PLUG		LIST NO. 52005-42	DUAL-BANANA PLUG (UNIT) & EVEREST/COBALT INST. PLUG
LIST NO. 52005-43	Darters/WOLF PLUG (UNIT) & DAVOL INST. PLUG		LIST NO. 52005-44	DUAL-BANANA PLUG (UNIT) & DAVOL INST. PLUG
LIST NO. 52005-45 / 5991	Darters/WOLF PLUG (UNIT) & AESCULAP/DAVOL/MARINA 2-PIN INST. PLUG		LIST NO. 52005-46 / 5990	DUAL-BANANA PLUG (UNIT) & AESCULAP/DAVOL/MARINA 2-PIN INST. PLUG
LIST NO. 52005-60	Darters/WOLF PLUG (UNIT) & LINVATEC/WECK/PILLING INST. PLUG		LIST NO. 52005-61	DUAL-BANANA PLUG (UNIT) & LINVATEC/WECK/PILLING INST. PLUG
LIST NO. 52005-91	Darters/WOLF PLUG (UNIT) & JARIT, ERBE INST. PLUG		LIST NO. 52005-92	DUAL-BANANA PLUG (UNIT) & JARIT, ERBE INST. PLUG
LIST NO. 52005-13	Darters/WOLF PLUG (UNIT) & Darters BI-CUT SCISSORS		LIST NO. 52005-14	DUAL-BANANA PLUG (UNIT) & Darters BI-CUT SCISSORS

**BIPOLAR CABLE ADAPTERS**



LIST NO. 5352	ADAPTER FOR Darters / WOLF GENERATOR PLUG & 4MM FEMALE BANANA CABLE PLUGS
------------------	---



LIST NO. 52005-83	ADAPTER FOR DUAL MALE BANAN GENERATOR PLUGS & Darters / WOLF RECEPTACLE PLUG
----------------------	--



LIST NO. 52005-84	ADAPTER FOR DUAL MALE BANANA GENERATOR PLUGS & WOLF KLEPPINGER FORCEPS PLUG
----------------------	---



Fig. 1



Fig. 2



Fig. 3

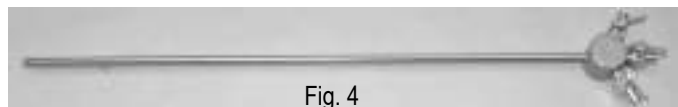

Fig. 4

LIST NO. 52205-30	IRRIGATION / SUCTION TUBE w/ LUER FITTING, 33cm, 5mm DIA. -- <b>Fig. 1</b>
LIST NO. 52105-26	IRRIGATION / SUCTION TUBE w/ LUER FITTING, 45cm, 5mm DIA.
LIST NO. 52205-31.*	ASPIRATION NEEDLE, 33cm, 5mm DIA., 15 GAUGE NEEDLE STANDARD (SPECIFY *18 GA. - 25 GA.) -- <b>Fig. 2</b>
LIST NO. 52105-27.*	ASPIRATION NEEDLE, 45cm, 5mm DIA., 15 GAUGE NEEDLE STANDARD (SPECIFY *18 GA. - 25 GA.)
LIST NO. 52105-27W	ASPIRATION NEEDLE w/ ANGLED 45° TUBE, 15 GAUGE NEEDLE STANDARD (SPECIFY *18 GA. - 25 GA.) -- <b>Fig. 3</b>
LIST NO. 52205-31R*	RETRACTABLE ASPIRATION NEEDLE, 33cm, 5mm DIA., 15 GAUGE NEEDLE STANDARD (SPECIFY *18 GA. - 25 GA.)
LIST NO. 52105-27R*	RETRACTABLE ASPIRATION NEEDLE, 45cm, 5mm DIA., 15 GAUGE NEEDLE STANDARD (SPECIFY *18 GA. - 25 GA.)
LIST NO. 52205-32	IRRIGATION / SUCTION PROBE w/ CM MARKINGS & STOPCOCK, 33cm, 5mm DIA.
LIST NO. 52105-28	IRRIGATION / SUCTION PROBE w/ CM MARKINGS & STOPCOCK, 45cm, 5mm DIA.
LIST NO. 52205-32T	IRRIGATION / SUCTION PROBE w/ CM MARKINGS & TRUMPET VALVE, 33cm, 5mm DIA.
LIST NO. 52105-28T	IRRIGATION / SUCTION PROBE w/ CM MARKINGS & TRUMPET VALVE, 45cm, 5mm DIA.
LIST NO. 52205-33	LAVAGE CANNULA w/ 3-WAY STOPCOCK, POOLE SUCTION TIP w/ LATERAL HOLES, 33cm, 5mm DIA.-- <b>Fig. 4</b>
LIST NO. 52105-33	LAVAGE CANNULA w/ 3-WAY STOPCOCK, POOLE SUCTION TIP w/ LATERAL HOLES, 45cm, 5mm DIA.



LIST NO. 52450-10	Darters CO <sub>2</sub> DRIVEN IRRIGATION PUMP w/ FOUR BOTTLE STANDS FOR PLASTIC BOTTLES w/ IRRIGATION SOLUTION (INCLUDES LOW PRESSURE HOSES)
-------------------	---

**REQUIRED ACCESSORIES:**

LIST NO. 52105-28T	IRRIGATION / SUCTION PROBE w/ CM MARKINGS & TRUMPET VALVE, 45cm, 5mm DIA.
LIST NO. 52205-33	LAVAGE CANNULA w/ 3-WAY STOPCOCK, POOLE SUCTION TIP w/ LATERAL HOLES, 33cm, 5mm DIA.

**FEATURES OF THE Darters CO<sub>2</sub> DRIVEN IRRIGATION PUMP:**

•The **Darters CO<sub>2</sub> DRIVEN IRRIGATION PUMP** uses carbon dioxide from an external high pressure supply and reduces the pressure to an acceptable level for pumping irrigation solutions.

•The pressure is continuously variable. A pressure gauge monitors the irrigation pressure setting. The irrigation fitting is a quick-disconnect type for convenience.

•Incorporated into the **Darters CO<sub>2</sub> DRIVEN IRRIGATION PUMP** is a safety valve which completely stops the flow of gas if an irrigation solution bottle becomes empty. This unique feature prevents any gas from being delivered to the operation area.

**INDIVIDUAL COMPONENTS:**

LIST NO. 52105-28T	IRRIGATION / SUCTION PROBE w/ CM MARKINGS & TRUMPET VALVE, 45cm, 5mm DIA.
LIST NO. 52205-33	LAVAGE CANNULA w/ 3-WAY STOPCOCK, POOLE SUCTION TIP w/ LATERAL HOLES, 33cm, 5mm DIA.
LIST NO. 52205-33	LAVAGE CANNULA w/ 3-WAY STOPCOCK, POOLE SUCTION TIP w/ LATERAL HOLES, 45cm, 5mm DIA.

*We offer complete solution for Electrosurgical Accessories for hospital at the right price.*

EXTRA LARGE SUCTION PORTS

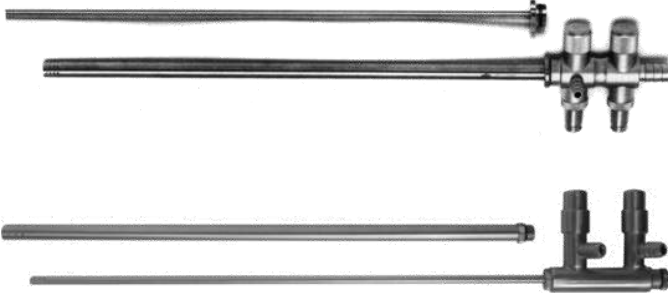

LIST NO. 52500-15	IRRIGATION / SUCTION SYSTEM W/ DUAL-VALVE HANDLE, COMPLETE W/ 33CM, 10MM & 5MM DIAMETER CANNULA
----------------------	---

LIST NO. 52500-30	IRRIGATION / SUCTION SYSTEM W/ DOUBLE "O" RING TRUMPET VALVE HANDLE, W/ INSTRUMENT CHANNEL, COMPLETE W/ 33CM, 10MM & 5MM DIAMETER CANNULA
----------------------	---

LIST NO. 52500-31	IRRIGATION / SUCTION SYSTEM W/ DOUBLE "O" RING TRUMPET VALVE HANDLE, W/ INSTRUMENT CHANNEL, COMPLETE W/ 45CM, 10MM & 5MM DIAMETER CANNULA
----------------------	---

TWO-WAY VALVE IRRIGATION/SUCTION SYSTEM



LIST NO. 52500-25	IRRIGATION / SUCTION SYSTEM W/ TWO-WAY LEVER VALVE, CANNULA W/ CENTRAL & LATERAL DISTAL OPENINGS, 33CM, 5MM DIAMETER CANNULA
----------------------	--

LIST NO. 52500-26	IRRIGATION / SUCTION SYSTEM W/ TWO-WAY LEVER VALVE, CANNULA W/ CENTRAL & LATERAL DISTAL OPENINGS, 5MM DIAMETER, 45CM
----------------------	--

NETZHAT STYLE IRRIGATION/SUCTION SYSTEM



LIST NO. 52500-16	NETZHAT STYLE IRRIGATION / SUCTION SYSTEM W/ DUAL TRUMPET VALVE HANDLE, COMPLETE W/ 33CM, 10MM & 5MM DIAMETER CANNULA
----------------------	---

CORSON STYLE IRRIGATION/SUCTION SYSTEM



LIST NO. 52205-94	CORSON STYLE IRRIGATION / SUCTION SYSTEM (NOT INCLUDING NEEDLE ELECTRODE), w/ 33cm, 5mm DIAMETER CANNULA
----------------------	--

LIST NO. 52205-95	CORSON STYLE NEEDLE ELECTRODE FOR CANNULA
----------------------	---

LIST NO. 52003-13	SEALING CAP FOR CORSON STYLE CANNULA, (PKG. OF 10)
----------------------	--

Monopolar Cables For Use With Corson Style Irrigation / Suction System



LIST NO. 52005-35
4MM DIA. PLUG (UNIT) & CORSON NEEDLE ELECTRODE INST. PLUG



LIST NO. 52005-36
8MM DIA. "BOVIE" PLUG (UNIT) & CORSON NEEDLE ELECTRODE INST. PLUG

*We offer complete solution for Electrosurgical Accessories for hospital at the right price.*

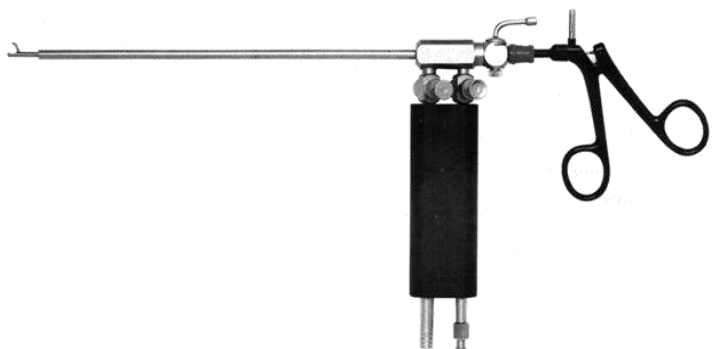

LIST NO. 52500-10	McLUCAS TRIPLE-FUNCTION HANDLE, COMPLETE w/ 33cm, 5mm DIAMETER CANNULA (Illustrated w/ an instrument inserted through its center)
----------------------	---

**TECHNICAL & ORDERING DATA FOR McLUCAS & Darters  
TRIPLE-FUNCTION CANNULA COMPLETE SYSTEMS**

LIST NO. 52500-00	IRRIGATION / SUCTION CANNULA SYSTEM ACCORDING TO BRUCE McLUCAS, M.D., w/ 33cm CANNULA; INCLUDES: LIST NO. 52500-10 HANDLE & LIST NOS. 52510-01 & 52505-21 CANNULA
LIST NO. 52500-01	IRRIGATION / SUCTION CANNULA SYSTEM ACCORDING TO BRUCE McLUCAS, M.D., w/ 45cm CANNULA; INCLUDES: LIST NO. 52500-10 HANDLE & LIST NOS. 52510-03 & 52505-23 CANNULA
LIST NO. 52500-02	IRRIGATION / SUCTION CANNULA SYSTEM, w/ 33cm CANNULA; INCLUDES: LIST NO. 52500-11 HANDLE & LIST NOS. 52510-01 & 52505-21 CANNULA
LIST NO. 52500-03	IRRIGATION / SUCTION CANNULA SYSTEM, w/ 45cm CANNULA; INCLUDES: LIST NO. 52500-11 HANDLE & LIST NOS. 52510-03 & 52505-23 CANNULA



LIST NO. 52500-11	Darters TRIPLE-FUNCTION HANDLE, w/ DUAL TRUMPET VALVES, COMPLETE w/ 33cm, 5mm DIAMETER CANNULA
----------------------	--

**INDIVIDUAL COMPONENTS:**

LIST NO. 52500-10	MCLUCAS TRIPLE-FUNCTION SUCTION/IRRIGATION LONG HANDLE W/ TWO 7MM DIAMETER TRUMPET VALVES, WITHOUT CANNULA
LIST NO. 52500-11	Darters TRIPLE-FUNCTION SUCTION/IRRIGATION SHOR HANDLE W/ TWO 7MM DIAMETER TRUMPET VALVES, WITHOUT CANNULA
LIST NO. 52505-21	5MM DIA., 33CM LONG CANNULA, (FOR 3MM DIAMETER INSTRUMENTS)
LIST NO. 52505-22	5MM DIA., 33CM LONG SUCTION CANNULA, W/ POOLE SUCTION TIP
LIST NO. 52505-23	5MM DIA., 45CM LONG CANNULA, (FOR 3MM DIAMETER INSTRUMENTS)
LIST NO. 52505-24	5MM DIA., 45CM LONG SUCTION CANNULA, W/ POOLE SUCTION TIP
LIST NO. 52510-01	10MM DIA., 33CM LONG CANNULA, (FOR 3MM DIAMETER INSTRUMENTS)
LIST NO. 52510-02	10MM DIA., 33CM LONG SUCTION CANNULA, 5MM DIA., W/ POOLE SUCTION TIP
LIST NO. 52510-03	10MM DIA., 45CM LONG CANNULA, 5MM DIA. (FOR 3MM DIAMETER INSTRUMENTS)
LIST NO. 52510-04	10MM DIA., 45CM LONG SUCTION CANNULA, 5MM DIA., W/ POOLE SUCTION TIP



**FOR 5 MM, SINGLE CLIP APPLIERS**

LIST NO. 52525-70	5MM Ø, 33CM LAP. CLIP APPLICATOR FOR SMALL ETHICON CLIPS, 3-PIECE SCREW-APART
LIST NO. 52525-71	5MM Ø, 33CM LAP. CLIP APPLICATOR FOR MEDIUM ETHICON CLIPS, 3-PIECE SCREW-APART
LIST NO. 52515-102	5MM, 45CM LAP CLIP APPLIER FOR SMALL ETHICON CLIPS, 3-PIECE TAKE APART
LIST NO. 52515-103	5MM, 45CM LAP CLIP APPLIER FOR MEDIUM ETHICON CLIPS, 3 PIECE TAKE APART
LIST NO. 52515-104	5MM, 45CM LAP CLIP APPLIER FOR SMALL Darters/PILLING WECK TITANIUM CLIPS, 3-PIECE TAKE APART
LIST NO. 52515-105	5MM, 45CM LAP CLIP APPLIER FOR MEDIUM Darters/PILLING WECK TITANIUM CLIPS, 3-PIECE TAKE APART

**Features for 5 & 10 MM Ø Clip Appliers::**

- Modular, 3-piece screw-apart instrument for simple cleaning
- Constructed of the highest grade stainless steel
- Durable, non-deforming jaw for consistent clip application



**FOR 10 MM, SINGLE CLIP APPLIERS**

*PILLING WECK STYLE*

LIST NO. 52511-10	10 MM DIA., 33 CM LAP CLIP APPLICATOR, MEDIUM PILLING (WECK) CLIPS, ROTATABLE, ONE-PIECE WITH FLUSH PORT
LIST NO. 52511-11	10 MM DIA., 33 CM LAP CLIP APPLICATOR, MEDIUM-LARGE PILLING (WECK) CLIPS, ROTATABLE, ONE-PIECE WITH FLUSH PORT
LIST NO. 52511-12	10 MM DIA., 45 CM LAP CLIP APPLICATOR, LARGE PILLING (WECK) CLIPS, ROTATABLE, ONE-PIECE WITH FLUSH PORT
LIST NO. 52511-36	10MM Ø, 33CM LAP. CLIP APPLICATOR FOR MEDIUM PILLING (WECK) CLIPS, 3-PIECE SCREW-APART
LIST NO. 52511-37	10MM Ø, 33CM LAP. CLIP APPLICATOR FOR MEDIUM-LARGE PILLING (WECK) CLIPS, 3-PIECE SCREW-APART



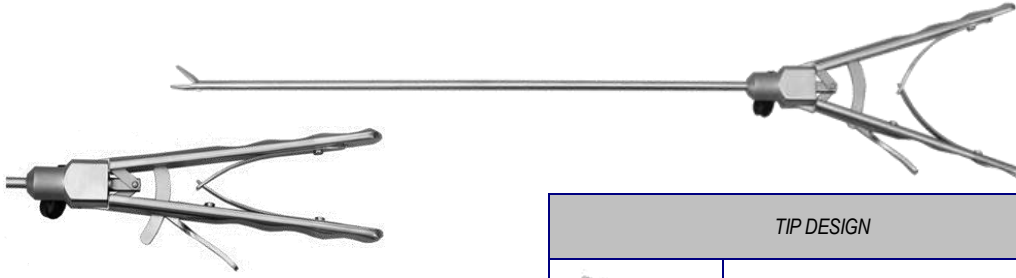

*ETHICON STYLE*

LIST NO. 52511-14	10MM 33CM LAP CLIP APPLICATOR FOR ETHICON MEDIUM LARGE CLIPS, ROTATABLE ONE PIECE WITH FLUSH PORT
LIST NO. 52525-80	10MM Ø, 33CM LAP. CLIP APPLICATOR FOR SMALL ETHICON CLIPS, 3-PIECE SCREW-APART
LIST NO. 52525-81	10MM Ø, 33CM LAP. CLIP APPLICATOR FOR MEDIUM ETHICON CLIPS, 3-PIECE SCREW-APART
LIST NO. 52525-82	10MM Ø, 33CM LAP. CLIP APPLICATOR FOR MEDIUM-LARGE ETHICON CLIPS, 3-PIECE SCREW-APART
LIST NO. 52525-83	10MM Ø, 33CM LAP. CLIP APPLICATOR FOR LARGE ETHICON CLIPS, 3-PIECE SCREW-APART
LIST NO. 52525-84	10MM Ø, 45CM LAP. CLIP APPLICATOR FOR SMALL ETHICON CLIPS, 3-PIECE SCREW-APART
LIST NO. 52525-85	10MM Ø, 45CM LAP. CLIP APPLICATOR FOR MEDIUM ETHICON CLIPS, 3-PIECE SCREW-APART
LIST NO. 52525-86	10MM Ø, 45CM LAP. CLIP APPLICATOR FOR MEDIUM-LARGE ETHICON CLIPS, 3-PIECE SCREW-APART
LIST NO. 52525-87	10MM Ø, 45CM LAP. CLIP APPLICATOR FOR LARGE ETHICON CLIPS, 3-PIECE SCREW-APART



Features:



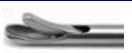

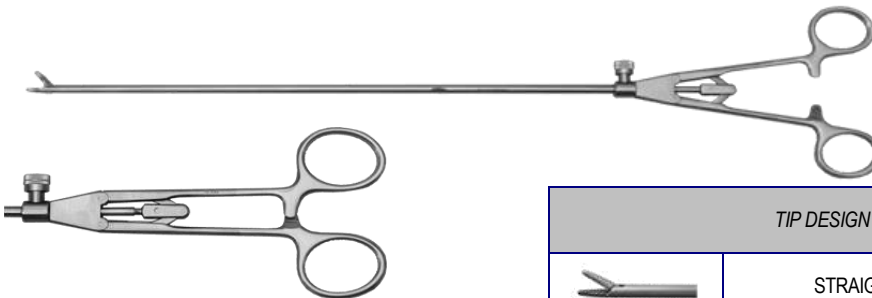
- Our most popular design
- Maximum holding power, quick, easy finger release ratchet
- The handle gives the user the most precise, ergonomically hand manipulation
  - Completely reusable

TIP DESIGN		33 CM SHAFT	45 CM SHAFT
	STRAIGHT 8 MM TC TIP	LIST NO. 52505-60	LIST NO. 52515-60
	CURVED LEFT TC TIP	LIST NO. 52505-62	LIST NO. 52515-62
	CURVED RIGHT TC TIP	LIST NO. 52505-63	LIST NO. 52515-63
	SELF-RIGHTING NEEDLE TIP	LIST NO. 52505-64	LIST NO. 52515-64
	CLOSED SELF-RIGHTING NEEDLE TIP	LIST NO. 52505-65	LIST NO. 52515-65



Features:





- One of our most cost effective products
  - Solid quick release
- The handle gives the user the most precise, ergonomically hand manipulation
  - Completely reusable

TIP DESIGN		33 CM SHAFT	45 CM SHAFT
	STRAIGHT 8 MM TC TIP	LIST NO. 52505-45	LIST NO. 52515-45
	CURVED LEFT TC TIP	LIST NO. 52505-46	LIST NO. 52515-46
	CURVED RIGHT TC TIP	LIST NO. 52505-47	LIST NO. 52515-47
	SELF-RIGHTING NEEDLE TIP	LIST NO. 52505-66	LIST NO. 52515-66
	CLOSED SELF-RIGHTING NEEDLE TIP	LIST NO. 52505-67	LIST NO. 52515-67



Features:



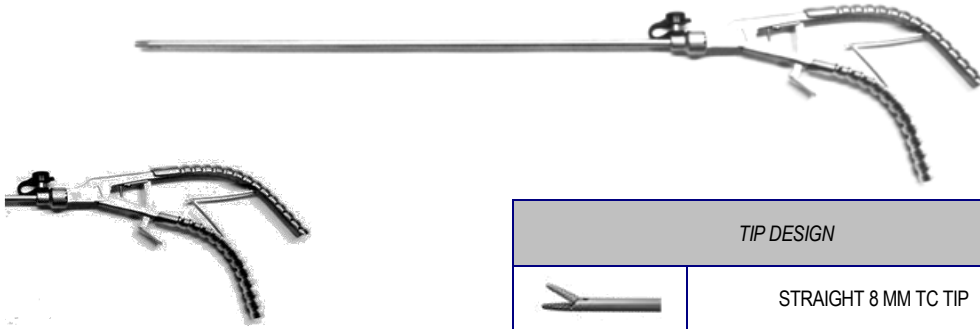

- Shorter, lightweight double-action axial handle
  - Solid quick thumb release
- The handle gives the user the most precise, ergonomically hand manipulation
  - Completely reusable

TIP DESIGN		33 CM SHAFT	45 CM SHAFT
	STRAIGHT 8 MM TC TIP	LIST NO. 52505-77	LIST NO. 52515-77
	CURVED LEFT TC TIP	LIST NO. 52505-78	LIST NO. 52515-78
	CURVED RIGHT TC TIP	LIST NO. 52505-79	LIST NO. 52515-79
	SELF-RIGHTING NEEDLE TIP	LIST NO. 52505-82	LIST NO. 52515-82
	CLOSED SELF-RIGHTING NEEDLE TIP	LIST NO. 52505-83	LIST NO. 52515-83







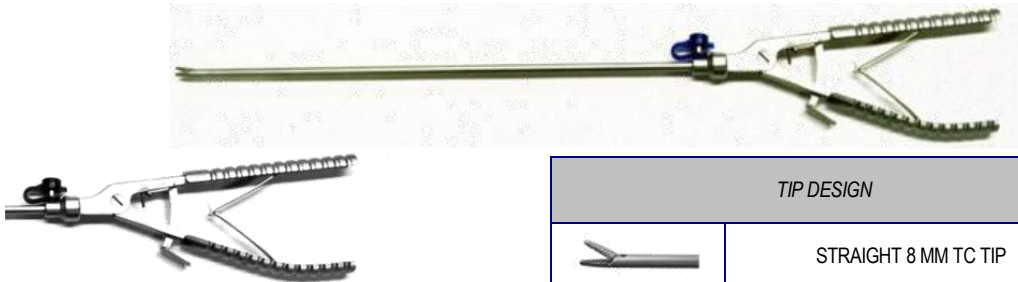

- Features:
- Lightweight curved down handle
  - Maximum holding power, quick, easy finger release ratchet
    - Completely reusable

TIP DESIGN		33 CM SHAFT	45 CM SHAFT
	STRAIGHT 8 MM TC TIP	LIST NO. 52505-70	LIST NO. 52515-70
	CURVED LEFT TC TIP	LIST NO. 52505-71	LIST NO. 52515-71
	CURVED RIGHT TC TIP	LIST NO. 52505-72	LIST NO. 52515-72
	SELF-RIGHTING NEEDLE TIP	LIST NO. 52505-73	LIST NO. 52515-73
	CLOSED SELF-RIGHTING NEEDLE TIP	LIST NO. 52505-74	LIST NO. 52515-74







- Features:
- Lightweight ergonomic handle for c comfortable grip
    - Solid quick release
    - Completely reusable

TIP DESIGN		33 CM SHAFT	45 CM SHAFT
	STRAIGHT 8 MM TC TIP	LIST NO. 52505-85	LIST NO. 52515-85
	CURVED LEFT TC TIP	LIST NO. 52505-86	LIST NO. 52515-86
	CURVED RIGHT TC TIP	LIST NO. 52505-87	LIST NO. 52515-87
	SELF-RIGHTING NEEDLE TIP	LIST NO. 52505-88	LIST NO. 52515-88
	CLOSED SELF-RIGHTING NEEDLE TIP	LIST NO. 52505-89	LIST NO. 52515-89



- Features:
- Curved down single action ring handle with ratchet
  - The handle gives the user the most precise, ergonomically hand manipulation
    - Completely reusable

TIP DESIGN		33 CM SHAFT	45 CM SHAFT
	STRAIGHT 8 MM TC TIP	LIST NO. 52505-100	LIST NO. 52515-100
	CURVED LEFT TC TIP	LIST NO. 52505-101	LIST NO. 52515-101
	CURVED RIGHT TC TIP	LIST NO. 52505-102	LIST NO. 52515-102
	SELF-RIGHTING NEEDLE TIP	LIST NO. 52505-103	LIST NO. 52515-103
	CLOSED SELF-RIGHTING NEEDLE TIP	LIST NO. 52505-90	LIST NO. 52515-90

We offer complete solution for Electrosurgical Accessories for hospital at the right price.



LIST NO.	5MM, 33CM, Darters HYBRID NEEDLE HOLDER / SCISSORS, STRAIGHT TIP W/ DOUBLE ACTION, ON DEMAND ON/OFF, STRAIGHT AXIAL HANDLE
LIST NO.	5MM, 45CM, , Darters HYBRID NEEDLE HOLDER / SCISSORS, STRAIGHT TIP W/ DOUBLE ACTION, ON DEMAND ON/OFF, STRAIGHT AXIAL HANDLE

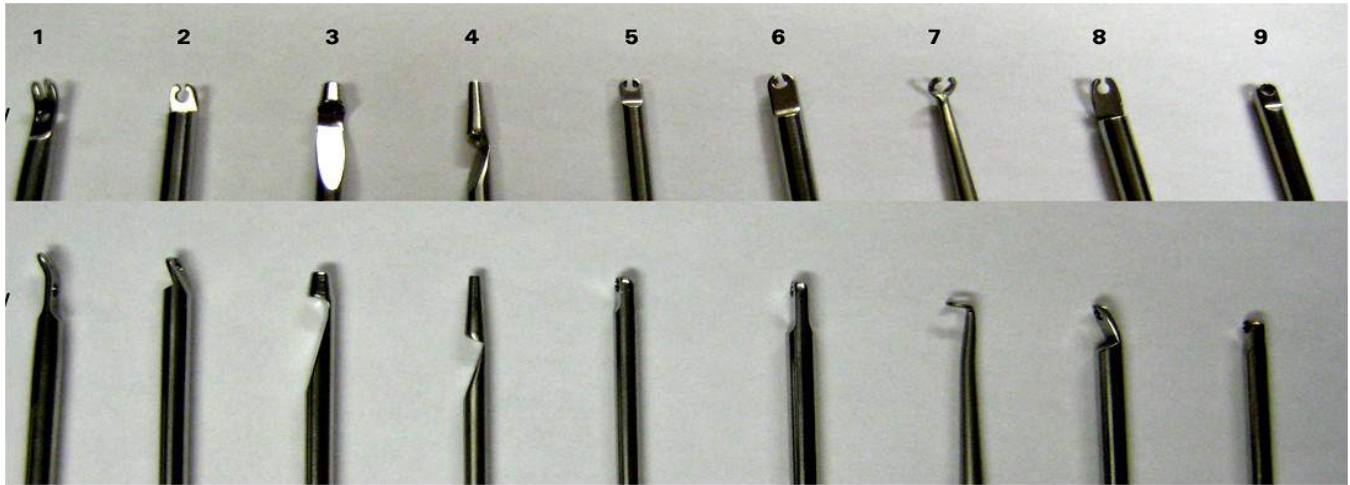

DESCRIPTION	33CM LIST NO.	45CM LIST NO.
Darters KNOT PUSHER, STAINLESS STEEL 5mm DIA., STYLE 1	52205-61-01	52105-61-01
Darters KNOT PUSHER, STAINLESS STEEL 5mm DIA., STYLE 2	52205-61-02	52105-61-02
Darters KNOT PUSHER, STAINLESS STEEL 5mm DIA., STYLE 3	52205-61-03	52105-61-03
Darters KNOT PUSHER, STAINLESS STEEL 5mm DIA., STYLE 4	52205-61-04	52105-61-04
Darters KNOT PUSHER, STAINLESS STEEL 5mm DIA., STYLE 5	52205-61-05	52105-61-05
Darters KNOT PUSHER, STAINLESS STEEL 5mm DIA., STYLE 6	52205-61-06	52105-61-06
Darters KNOT PUSHER, STAINLESS STEEL 5mm DIA., STYLE 7	52205-61-07	52105-61-07
Darters KNOT PUSHER, STAINLESS STEEL 5mm DIA., STYLE 8	52205-61-08	52105-61-08
Darters KNOT PUSHER, STAINLESS STEEL 5mm DIA., STYLE 9	52205-61-09	52105-61-09
Darters KNOT PUSHER, CLOSED, STAINLESS STEEL 5mm DIA., STYLE 1	52205-61-01C	52105-61-01C
Darters KNOT PUSHER, CLOSED, STAINLESS STEEL 5mm DIA., STYLE 2	52205-61-02C	52105-61-02C
Darters KNOT PUSHER, CLOSED, STAINLESS STEEL 5mm DIA., STYLE 5	52205-61-05C	52105-61-05C
Darters KNOT PUSHER, CLOSED, STAINLESS STEEL 5mm DIA., STYLE 6	52205-61-06C	52105-61-06C
Darters KNOT PUSHER, CLOSED, STAINLESS STEEL 5mm DIA., STYLE 7	52205-61-07C	52105-61-07C
Darters KNOT PUSHER, CLOSED, STAINLESS STEEL 5mm DIA., STYLE 8	52205-61-018C	52105-61-018C



LIST NO. 52125-72	5MM, 45CM, "CLARKE-REICH MACRO" KNOT PUSHER LIGATOR FOR USE WITH 6-0 AND SMALLER SUTURE SIZES - SLOTTED TIP
LIST NO. 52225-72	5MM, 29CM, "CLARKE-REICH MACRO" KNOT PUSHER LIGATOR FOR USE WITH 6-0 AND SMALLER SUTURE SIZES - SLOTTED TIP

*We offer complete solution for Electrosurgical Accessories for hospital at the right price.*



SPRING HANDLE



SYRINGE STYLE



PRECISION MICRO-POINTED AND POLISHED TIP WITH PLATFORM ON ALL OF SUTURE RETRIEVERS

LIST NO. 52203-41	Darters LAPAROSCOPIC TROCAR INCISION WOUND CLOSURE & HERNIA SUTURE RETRIEVER- 3.0 MM DIAMETER, 17 CM WORKING LENGTH, SPRING HANDLE, CLEANING FLUSH PORT, PRECISION MICRO-POINTED & POLISHED TIP W/ PLATFORM
LIST NO. 52203-41C	Darters LAPAROSCOPIC TROCAR INCISION WOUND CLOSURE & HERNIA SUTURE RETRIEVER- 3.0 MM DIAMETER, 17 CM WORKING LENGTH, SPRING HANDLE, CLEANING FLUSH PORT, PRECISION MICRO-POINTED & POLISHED TIP W/ PLATFORM, (2-PIECE TAKE APART)
LIST NO. 52213-41	Darters BARIATRIC LAPAROSCOPIC TROCAR INCISION WOUND CLOSURE & HERNIA SUTURE RETRIEVER- 3.0 MMDIAMETER, 20 CM WORKING LENGTH, SPRING HANDLE, CLEANING FLUSH PORT, PRECISION MICRO-POINTED & POLISHED TIP W/ PLATFORM
LIST NO. 52213-41C	Darters BARIATRIC LAPAROSCOPIC TROCAR INCISION WOUND CLOSURE & HERNIA SUTURE RETRIEVER- 3.0 MM DIAMETER, 20 CM WORKING LENGTH, SPRING HANDLE, CLEANING FLUSH PORT, PRECISION MICRO-POINTED & POLISHED TIP W/ PLATFORM (2-PIECE TAKE APART)
LIST NO. 52203-00	Darters LAPAROSCOPIC TROCAR INCISION WOUND CLOSURE & HERNIA SUTURE RETRIEVER- 3.0 MM DIAMETER, 17 CM WORKING LENGTH, SYRINGE HANDLE, CLEANING FLUSH PORT, PRECISION MICRO-POINTED & POLISHED TIP W/ PLATFORM
LIST NO. 52213-00	Darters LAPAROSCOPIC TROCAR INCISION WOUND CLOSURE & HERNIA SUTURE RETRIEVER- 3.0 MM DIAMETER, 20 CM WORKING LENGTH, SYRINGE HANDLE, CLEANING FLUSH PORT, PRECISION MICRO-POINTED & POLISHED TIP W/ PLATFORM

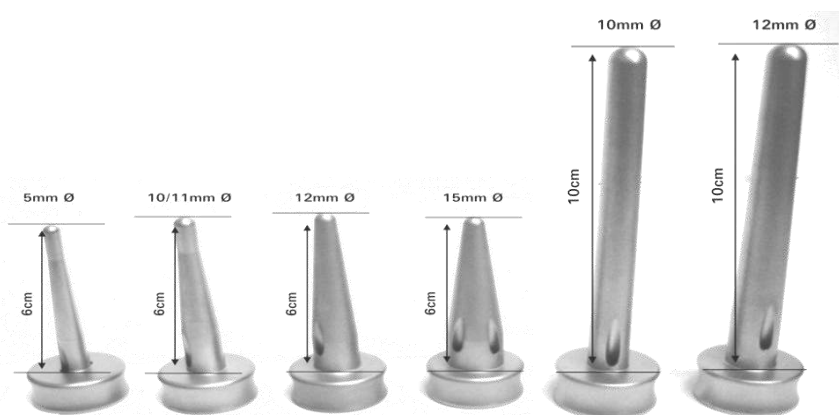

6CM LENGTH		10CM LENGTH	
LIST NO. 52203-05	5MM DIAMETER	LIST NO. 52204-05	5MM DIAMETER
LIST NO. 52203-10/11	10/11MM DIAMETER	LIST NO. 52204-10/11	10/11MM DIAMETER
LIST NO. 52203-12	12MM DIAMETER	LIST NO. 52204-12	12MM DIAMETER
LIST NO. 52203-15	15MM DIAMETER	LIST NO. 52204-15	15MM DIAMETER

We offer complete solution for Electrosurgical Accessories for hospital at the right price.

Introducing another environmentally-friendly, surgical cost reduction, "Green" reusable instrument at the most economical price



THERMOPLASTIC 5MM DIA., SMOOTH SLEEVE



THERMOPLASTIC 5MM DIA., THREADED SLEEVE

52900-05	5MM, 103MM "LITE" THERMOPLASTIC TROCAR SLEEVE
52900-10	10MM, 103MM "LITE" THERMOPLASTIC TROCAR SLEEVE
52900-11	11MM, 103MM "LITE" THERMOPLASTIC TROCAR SLEEVE
52900-12	12MM, 103MM "LITE" THERMOPLASTIC TROCAR SLEEVE
52900-15	15MM, 103MM "LITE" THERMOPLASTIC TROCAR SLEEVE

52900-05T	5MM, 103MM "LITE" THERMOPLASTIC TROCAR SLEEVE, THREADED
52900-10T	10MM, 103MM "LITE" THERMOPLASTIC TROCAR SLEEVE, THREADED
52900-11T	11MM, 103MM "LITE" THERMOPLASTIC TROCAR SLEEVE, THREADED
52900-12T	12MM, 103MM "LITE" THERMOPLASTIC TROCAR SLEEVE, THREADED
52900-15T	15MM, 103MM "LITE" THERMOPLASTIC TROCAR SLEEVE, THREADED

52904-05	5MM, 120MM "LITE" THERMOPLASTIC TROCAR SLEEVE
52904-10	10MM, 120MM "LITE" THERMOPLASTIC TROCAR SLEEVE
52904-11	11MM, 120MM "LITE" THERMOPLASTIC TROCAR SLEEVE
52904-12	12MM, 120MM "LITE" THERMOPLASTIC TROCAR SLEEVE
52904-15	15MM, 120MM "LITE" THERMOPLASTIC TROCAR SLEEVE

52904-05T	5MM, 120MM "LITE" THERMOPLASTIC TROCAR SLEEVE, THREADED
52904-10T	10MM, 120MM "LITE" THERMOPLASTIC TROCAR SLEEVE, THREADED
52904-11T	11MM, 120MM "LITE" THERMOPLASTIC TROCAR SLEEVE, THREADED
52904-12T	12MM, 120MM "LITE" THERMOPLASTIC TROCAR SLEEVE, THREADED
52904-15	15MM, 120MM "LITE" THERMOPLASTIC TROCAR SLEEVE, THREADED



REUSABLE SLIDE & FLIP TOP REDUCER FOR THE Darters "LITE" TROCAR CANNULA SYSTEM



TRIPLE SLIDE REDUCER	
LIST NO. 52900-52	12MM TO 10/11MM TO 5MM

DOUBLE SLIDE REDUCER	
LIST NO. 52900-51	11MM TO 5MM DIA.
LIST NO. 52900-53	10MM TO 5MM DIA.
LIST NO. 52900-54	12MM TO 5MM DIA.



FLIP TOP REDUCER	
LIST NO. 52900-55	10/11MM TO 5MM
LIST NO. 52900-56	12MM TO 5MM

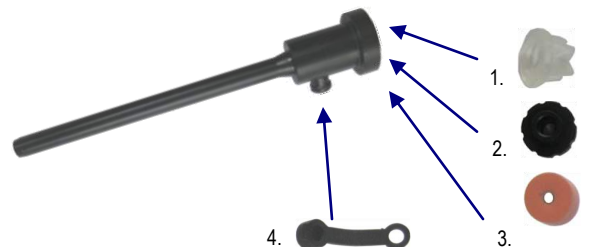

Minimum Number of Parts=Simple to Clean, Service & Assemble



52901-05	5MM, 103MM "LITE" PYRAMIDAL TROCAR
52901-10	10MM, 103MM "LITE" PYRAMIDAL TROCAR
52901-11	11MM, 103MM "LITE" PYRAMIDAL TROCAR
52901-12	12MM, 103MM "LITE" PYRAMIDAL TROCAR
52901-15	15MM, 103MM "LITE" PYRAMIDAL TROCAR

52902-05	5MM, 103MM "LITE" CONICAL TROCAR
52902-10	10MM, 103MM "LITE" CONICAL TROCAR
52902-11	11MM, 103MM "LITE" CONICAL TROCAR
52902-12	12MM, 103MM "LITE" CONICAL TROCAR
52902-15	15MM, 103MM "LITE" CONICAL TROCAR

52903-05	5MM, 103MM "LITE" DIAL-BLUNT TROCAR
52903-10	10MM, 103MM "LITE" DIAL-BLUNT TROCAR
52903-11	11MM, 103MM "LITE" DIAL-BLUNT TROCAR
52903-12	12MM, 103MM "LITE" DIAL-BLUNT TROCAR
52903-15	15MM, 103MM "LITE" DIAL-BLUNT TROCAR

52921-05	5MM, 120MM "LITE" PYRAMIDAL TROCAR
52921-10	10MM, 120MM "LITE" PYRAMIDAL TROCAR
52921-11	11MM, 120MM "LITE" PYRAMIDAL TROCAR
52921-12	12MM, 120MM "LITE" PYRAMIDAL TROCAR
52921-15	15MM, 120MM "LITE" PYRAMIDAL TROCAR

52922-10	10MM, 120MM "LITE" CONICAL TROCAR
52922-11	11MM, 120MM "LITE" CONICAL TROCAR
52922-12	12MM, 120MM "LITE" CONICAL TROCAR
52922-15	15MM, 120MM "LITE" CONICAL TROCAR
52902-15	15MM, 103MM "LITE" CONICAL TROCAR

52923-10	10MM, 120MM "LITE" DIAL-BLUNT TROCAR
52923-11	11MM, 120MM "LITE" DIAL-BLUNT TROCAR
52923-12	12MM, 120MM "LITE" DIAL-BLUNT TROCAR
52923-15	15MM, 120MM "LITE" DIAL-BLUNT TROCAR
52902-15	15MM, 103MM "LITE" CONICAL TROCAR

We offer complete solution for Electrosurgical Accessories for hospital at the right price.



STANDARD

DIAMETER	STANDARD 103MM LENGTH LIST NO.	X-TRA LONG 150MM LENGTH LIST NO.
3MM	52203-113	52203-213
5MM	52205-113	52205-213
6MM	52206-113	52206-213
7MM	52207-113	52207-213
8MM	52208-113	52208-213
9MM	52209-113	52209-213
10MM	52210-113	52210-13
11MM	52211-113	52211-213
12MM	52212-113	52212-213



THREADED

DIAMETER	STANDARD 103MM LENGTH LIST NO.	X-TRA LONG 150MM LENGTH LIST NO.
3MM	52203-113TS	52203-213TS
5MM	52205-113TS	52205-213TS
6MM	52206-113TS	52206-213TS
7MM	52207-113TS	52207-213TS
8MM	52208-113TS	52208-213TS
9MM	52209-113TS	52209-213TS
10MM	52210-113TS	52210-13TS
11MM	52211-113TS	52211-213TS
12MM	52212-113TS	52212-213TS

INNER CUTTING ASSEMBLY IS SPRING LOADED TO PROTECT CONTENTS OF THE ABDOMINAL CAVITY UPON PENETRATION



**STYLE A:** Blunt Obturator w/ oblique safety spring loaded cutting shield



**STYLE B:** Blunt Obturator w/ pyramidal safety lockable active shield

DIAMETER	STANDARD 103MM LENGTH LIST NO.	X-TRA LONG 150MM LENGTH LIST NO.
2MM	52202-112	52202-212
3MM	52203-112	52203-212
5MM	52205-112	52205-212
6MM	52206-112	52206-212
7MM	52207-112	52207-212
8MM	52208-112	52208-212
9MM	52209-112	52209-212
10MM	52210-112	52210-212
11MM	52211-112	52211-212
12MM	52212-112	52212-212

DIAMETER	STANDARD 103MM LENGTH LIST NO.
3MM	52203-122
5MM	52205-122
6MM	52206-122
7MM	52207-122
8MM	52208-122
9MM	52209-122
10MM	52210-122
12MM	52212-122

We offer complete solution for Electrosurgical Accessories for hospital at the right price.

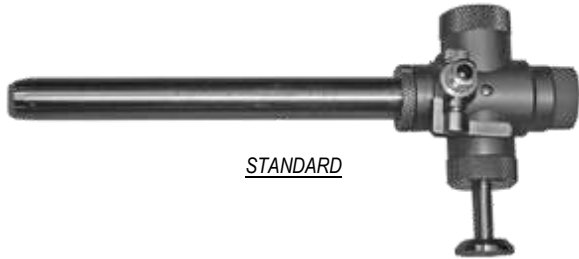

STANDARD

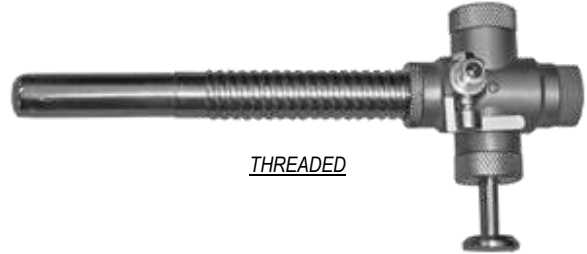

THREADED

DIAMETER	STANDARD 103MM LENGTH LIST NO.	X-TRA LONG 150MM LENGTH LIST NO.
2MM	52202-10	52202-09
3MM	52203-06	52203-07
5MM	52205-09	52205-08
6MM	52206-10	52206-13
7MM	52207-10	52207-11
8MM	52208-10	52208-13
10MM	52210-10	52210-13
11MM	52210-14	52210-17
12MM	52212-10	52212-13

DIAMETER	STANDARD 103MM LENGTH LIST NO.	X-TRA LONG 150MM LENGTH LIST NO.
2MM	52202-10TS	52202-09TS
3MM	52203-06TS	52203-07TS
5MM	52205-09TS	52205-08TS
6MM	52206-10TS	52206-13TS
7MM	52207-10TS	52207-11TS
8MM	52208-10TS	52208-13TS
10MM	52210-10TS	52210-13TS
11MM	52210-14TS	52210-17TS
12MM	52212-10TS	52212-13TS



DIAMETER	STANDARD LIST NO.	X-TRA LONG LIST NO.
2MM	52202-11	52202-13
3MM	52203-10	52203-04
5MM	52205-11	52205-05
6MM	52206-08	52206-14
7MM	52207-11	52207-09
8MM	52208-11	52208-14
10MM	52210-11	52210-14
11MM	52210-115	52210-18
12MM	52212-11	52212-14

DIAMETER	STANDARD LIST NO.	X-TRA LONG LIST NO.
2MM	52202-12	52202-14
3MM	52203-11	52203-05
5MM	52205-12	52205-04
6MM	52206-12	52206-15
7MM	52207-12	52207-15
8MM	52208-12	52208-15
10MM	52210-12	52210-15
11MM	52110-16	52110-19
12MM	52212-12	52212-15

DIAMETER	STANDARD LIST NO.	X-TRA LONG LIST NO.
2MM	52202-18	52202-19
3MM	52203-06	52203-07
5MM	52205-24	52205-25
6MM	52206-22	52206-23
7MM	52207-18	52207-19
8MM	52208-18	52208-19
10MM	52210-18	52210-19
11MM	52110-22	52110-23
12MM	52212-18	52212-19

We offer complete solution for Electrosurgical Accessories for hospital at the right price.

**CLASSIC HASSON CANNULA**  
TRUMPET VALVE, INCLUDING TROCAR, SLEEVE & CONE  
SUTURE POST



DIAMETER	STANDARD LENGTH LIST NO.
5MM	52205-199
8MM	52208-99
10MM	52210-99
11MM	52110-99
12MM	52212-99

**LIGHTWEIGHT HASSON CANNULA**  
MAGNA-CLOSE, INCLUDING TROCAR, SLEEVE & CONE  
SUTURE POST



DIAMETER	STANDARD LENGTH LIST NO.
5MM	52205-299
8MM	52208-199
10MM	52210-199
11MM	52110-199
12MM	52212-199



DIAMETER	STANDARD LENGTH LIST NO.
5-11MM	52001-22
10-15MM	52001-23



DIAMETER	STANDARD REDUCER MFOR FULL LENGTH OF SLEEVE LIST NO.	REDUCER W/ FLIP VALVE FOR SLEEVE TOP OPENING
5MM TO 3MM	52203-08	52205-80
12MM TO 5MM	52212-16	52212-80
10MM TO 5MM	52210-16	52210-80
11MM TO 5MM	52110-30	52210-80
12MM TO 5MM	52212-20	52212-81



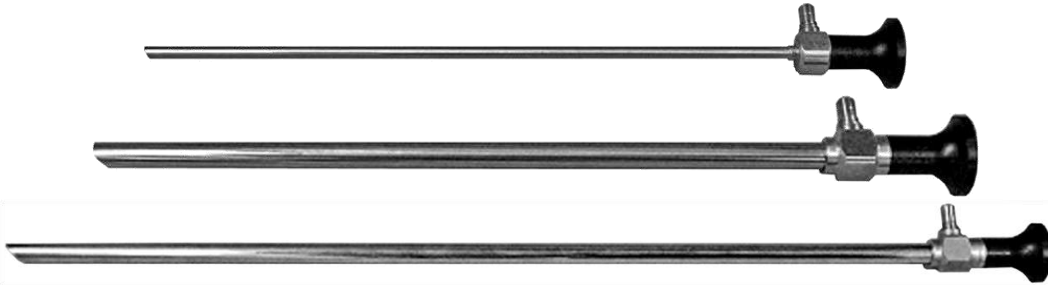
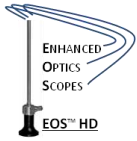

LIST NO.	DESCRIPTION
52205-00	EOS HD 0 DEGREE VIEWING, 5 MM DIAMETER, 260 MM LONG, AUTOCLAVABLE
52205-01	EOS HD 30 DEGREE VIEWING, 5 MM DIAMETER, 260 MM LONG, AUTOCLAVABLE.
52205-02	EOS HD 0 DEGREE VIEWING, 5 MM DIAMETER, 300 MM LONG, AUTOCLAVABLE
52205-03	EOS HD 30 DEGREE VIEWING, 5 MM DIAMETER, 300 MM LONG, AUTOCLAVABLE
52210-00	EOS HD 0 DEGREE VIEWING, 10 MM DIAMETER, 300 MM LONG, AUTOCLAVABLE
52210-01	EOS HD 30 DEGREE VIEWING, 10 MM DIAMETER, 300 MM LONG, AUTOCLAVABLE
52210-02	EOS HD 45 DEGREE VIEWING, 10 MM DIAMETER, 300 MM LONG, AUTOCLAVABLE
52215-00	EOS HD 0 DEGREE VIEWING, 10 MM DIAMETER, 500 MM LONG (FOR BARIATRIC SURGERY), AUTOCLAVABLE
52215-01	EOS HD 30 DEGREE VIEWING, 10 MM DIAMETER, 500 MM LONG (FOR BARIATRIC SURGERY), AUTOCLAVABLE



LIST NO. 52033-45	<i>Darters TP 11 TELESCOPE PREHEATER</i> INCLUDING 4 AUTOCLAVABLE TELESCOPE TUBES, STANDARD 10 MM (QTY.2), 5 MM (QTY.1), AND 4 MM (QTY.1)
LIST NO. 52003-46	REPLACEMENT TUBE

This unit connects to any conventional outlet (115 V), other voltages are available upon request

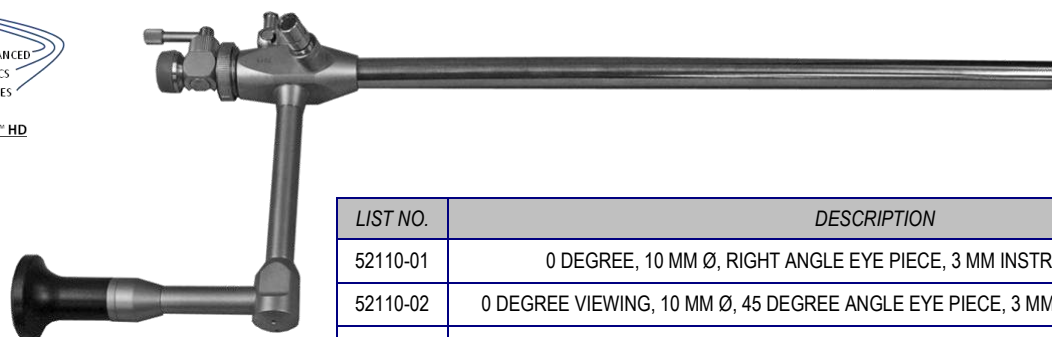
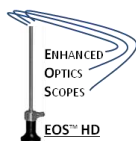

LIST NO.	DESCRIPTION
52110-01	0 DEGREE, 10 MM Ø, RIGHT ANGLE EYE PIECE, 3 MM INSTRUMENT CHANNEL
52110-02	0 DEGREE VIEWING, 10 MM Ø, 45 DEGREE ANGLE EYE PIECE, 3 MM INSTRUMENT CHANNEL.
52110-03	0 DEGREE VIEWING, 10 MM Ø, RIGHT ANGLE EYE PIECE, 5.5 MM INSTRUMENT CHANNEL
52110-04	0 DEGREE VIEWING, 11 MM Ø, 45 DEGREE ANGLE EYE PIECE, 6 MM INSTRUMENT CHANNEL
52110-05	0 DEGREE VIEWING, 11 MM Ø, RIGHT ANGLE EYE PIECE, 6 MM INSTRUMENT CHANNEL
52110-06	0 DEGREE VIEWING, 12 MM Ø, RIGHT ANGLE EYE PIECE, 7 MM INSTRUMENT CHANNEL
52110-07	0 DEGREE VIEWING, 12 MM Ø, 45 DEGREE ANGLE EYE PIECE, 7 MM INSTRUMENT CHANNEL
52110-08	0 DEGREE VIEWING, 10 MM Ø, 45 DEGREE ANGLE EYE PIECE, 5.5 MM INSTRUMENT CHANNEL

STOPCOCK ORDERING INFORMATION:	
LIST NO. 52110-00-01	REPLACEMENT STOPCOCK AND INSTRUMENT CHANNEL SEAL: 3MM DIA., FOR Darters SCOPES (#52110-01 & 52110-02)
LIST NO. 52110-00-03	REPLACEMENT STOPCOCK AND INSTRUMENT CHANNEL SEAL: 5.5MM DIA., FOR Darters SCOPES (#52110-03 & 52110-08)
LIST NO. 52110-00-05	REPLACEMENT STOPCOCK AND INSTRUMENT CHANNEL SEAL: 6MM DIA., FOR Darters SCOPES (#52110-04 & 52110-05)
LIST NO. 52110-00-06	REPLACEMENT STOPCOCK AND INSTRUMENT CHANNEL SEAL: 7MM DIA., FOR Darters SCOPES (#52110-06 & 52110-07)

SEALING CAP ORDERING INFORMATION:	
LIST NO. 52003-02	REPLACEMENT SEALING CAP FOR OPERATING SCOPE WITH 3MM DIA. INSTRUMENT CHANNEL, 12/PKG.
LIST NO. 52003-04	REPLACEMENT SEALING CAP FOR OPERATING SCOPE WITH 5.5MM DIA. INSTRUMENT CHANNEL, 12/PKG.
LIST NO. 52003-05	REPLACEMENT SEALING CAP FOR OPERATING SCOPE WITH 6MM DIA. INSTRUMENT CHANNEL, 12/PKG.
LIST NO. 52003-06	REPLACEMENT SEALING CAP FOR OPERATING SCOPE WITH 7MM DIA. INSTRUMENT CHANNEL, 12/PKG.

SPECIAL PARTS & CLEANING BRUSHES ORDERING INFORMATION:	
LIST NO. 52110-20	ADAPTER FOR ACMI FALLOPIAN RING APPLICATOR FOR Darters SCOPE #52110-06
LIST NO. 52003-29	CLEANING BRUSH FOR OPERATING SCOPE WITH 3MM DIA. INSTRUMENT CHANNEL, 12/PKG.
LIST NO. 52003-31	CLEANING BRUSH FOR OPERATING SCOPE WITH 5.5MM DIA. INSTRUMENT CHANNEL, 12/PKG.
LIST NO. 52003-23	CLEANING BRUSH FOR OPERATING SCOPE WITH 6MM DIA. INSTRUMENT CHANNEL, 12/PKG.
LIST NO. 52003-25	CLEANING BRUSH FOR OPERATING SCOPE WITH 7MM DIA. INSTRUMENT CHANNEL, 12/PKG.



**1ST GENERATION**

LIST NO. 52-5685	Darters ENDO-TEST UNIT - COMPLETE PACKAGE INCLUDES: AUTOCLAVABLE TEST ELECTRODES (INSULATION TEST); 3MM SPONGES (5), 5MM SPONGES (5) & 10MM SPONGES (5); TEST CABLE (INSULATION TEST). *PLEASE SPECIFY CABLE FOR VALLEYLAB UNIT IF REQUIRED – ORDER EXTRA
---------------------	---



**2ND GENERATION**

LIST NO. 52-5686	Darters ENDO-TEST UNIT WITH MONOPOLAR & BIPOLAR CABLE TESTER CIRCUIT COMPLETE PACKAGE INCLUDES SAME AS #52-5685 PLUS ADAPTER & CABLE REQUIRED FOR CABLE TEST
---------------------	---



**3RD GENERATION**

LIST NO. 52-5687	Darters ENDO-TEST UNIT WITH MONOPOLAR & BIPOLAR CABLE TESTER CIRCUIT W/ ADVANCED SENSORY DETECTION OF INSULATION DEFECTS: COMPLETE PACKAGE INCLUDES SAME A #52-5685 PLUS ADAPTERS & CABLE REQUIRED FOR CABLE TEST
---------------------	---

ACCESSORIES FOR ENDO-TEST:	
LIST NO. 52-5685-01	ELECTRODE FOR CAPACITANCE TEST
LIST NO. 52-5685-02	ELECTRODE FOR INSULATION TEST
LIST NO. 52-5685-03	5 MM SPONGE INSERT FOR INSULATION TEST (10/PKG.)
LIST NO. 52-5685-04	10 MM SPONGE INSERT FOR INSULATION TEST (10/PKG.)
LIST NO. 52-5685-05	TEST CABLE FOR INSULATION TEST W/ 4 MM FEMALE CONNECTOR
LIST NO. 52-5685-06	TEST CABLE FOR CAPACITANCE TEST W/ ¼" PHONO PLUG
LIST NO. 52-5685-07	*TEST CABLE FOR CAPACITANCE TEST FOR VALLEYLAB UNITS
LIST NO. 52-5685-08	3 MM SPONGE INSERT FOR INSULATION TEST (10/PKG.)

ACCESSORIES FOR CABLE TESTER:	
LIST NO. 52-5686-11	BIPOLAR ADAPTER CABLE
LIST NO. 52-5686-12	BOVIE PLUG ADAPTER
LIST NO. 52-5686-13	BANANA PLUG ADAPTER
LIST NO. 52-5686-14	BANANA PLUG CONVERTOR ADAPTER
LIST NO. 52-5680-15	BIPOLAR CABLE ADAPTER FOR KLEPPINGER FORCEPS CABLES
LIST NO. 52-5680-16	BIPOLAR CABLE ADAPTER FOR 2-PIN PLUG CABLES
LIST NO. 52-5680-17	ALLIGATOR TEST CLIP FOR ENDO-TESTER
LIST NO. 52-5685-10	INSULATED HANDLE TEST ELECTRODE W/ ATTACHED CABLE, FOR USE W/ INSULATION TEST ELECTRODE

*We offer complete solution for Electrosurgical Accessories for hospital at the right price.*



LIST NO. 52003-80	WATER JET CLEANING GUN FOR CONNECTION TO WATER FAUCET
----------------------	---

The Darters Instrument Cleaning Kit is an effective and easy-to-use solution to your laparoscopic instrumentation cleaning needs. It was designed with your convenience in mind.

**The Darters Instrument Cleaning Kit consists of List No. 52003-80 & List No. 52003-81**

- A) SHEATHS AND INSERTS, SYRINGES, INJECTION CANNULA
- B) SHEATHS, PIPETTES
- C) CATHETERS
- D) DRAINAGE TUBES
- E) COCKS, CANNULA AND SYRINGES
- F) BOTTLES
- G) DOUCHE FITTINGS
- H) WATER JET PUMP (ALSO SUITABLE FOR DRYING IN CONJUNCTION W/ THE FITTINGS)

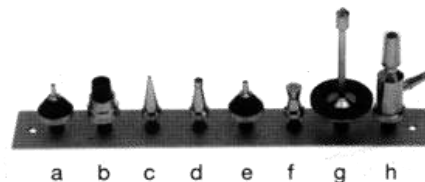

LIST NO. 52003-81	SET OF ADAPTERS FOR THE CLEANING OF (A) THROUGH (H)
----------------------	--

**ULTRASTOP "PRO MED" ANTI-FOGGING AGENT**



Ultrastop is the most cost-effective method of protecting your medical optics from fogging up: it eliminates the need to warm up your endoscopes prior to use; and due to its reusable sterile packaging (30 cc bottles) it can be used over and over again

LIST NO. 52003-37	ULTRASTOP, PER DOZEN BOTTLES
LIST NO. 52003-38	ULTRASTOP, PER BOTTLE

**LUBRICATING OIL FOR SURGICAL INSTRUMENTS**



To maintain high quality of costly surgical instrument joints and other components, a light application of surgical instruments should be made prior to sterilization

LIST NO. 52003-39	ONE DOZEN, 0.5 OZ EACH, NON-STERILE
LIST NO. 52003-40	ONE BOTTLE, 0.5 OZ. EACH, NON-STERILE

**CLEANING BRUSHES FOR ENDOSCOPIC INSTRUMENTS**



LIST NO. (QTY. 10)	STAINLESS STEEL WIRE AND ANTI-MICROBIAL BRUSHES MADE IN THE USA	LIST NO. (QTY. 1)
52003-56	2 MM Ø FOR 2MM Ø CANNULAS (12" LONG)	52003-57
52003-21	4 MM Ø FOR 3, 4 MM Ø CANNULAS (TROCAR SLEEVES, ETC) 12" LONG	52003-22
52003-23	6 MM Ø FOR 5, 6 MM Ø CANNULAS (TROCAR SLEEVES, ETC) 12" LONG	52003-24
52003-25	8 MM Ø FOR 7, 8 MM Ø CANNULAS (TROCAR SLEEVES, ETC) 12" LONG	52003-26
52003-27	12 MM Ø FOR 10, 11, 12 MM Ø CANNULAS (TROCAR SLEEVES, ETC) 12" LONG	52003-28
52003-29	4 MM Ø FOR 3, 4 MM Ø CANNULAS (SINGLE PUNCTURE LAPAROSCOPE, ETC) 19" LONG	52003-30
52003-31	6 MM Ø FOR 5, 6 MM Ø CANNULAS (S.P. LAPAROSCOPE, BIPOLAR FCPS, ETC) 19" LONG	52003-32
52003-33	8 MM Ø FOR 7, 8 MM Ø CANNULAS (S.P LAPAROSCOPE, SUCTION TUBES, ETC) 19" LONG	52003-34
52003-48	12 MM Ø FOR 10, 11, 12 MM Ø CANNULAS (LAP. INSTR. SUCTION TUBES, ETC) 19" LONG	52003-49
52003-35	VERESS NEEDLES (8" LONG)	52003-36
52003-41	NYLON BRISTLE BRUSH WITH HANDLE 7" LONG 52003-43	52003-42
52003-45	STAINLESS STEEL BRISTLE BRUSH WITH HANDLE 7" LONG	52003-47
52003-54	DOUBLE END NYLON BRISTLE BRUSH W/HANDLE FOR LAPAROSCOPIC INST. 7" LONG	52003-55

*We offer complete solution for Electrosurgical Accessories for hospital at the right price.*

***NEW FROM Darters!!!***

*Light Weight Aluminum Sterilization & Storage Containers That Can Hold Up To 16 Instruments (also available with a removable tray for general instruments as well)*



LIST NO. 52038-48	ALUMINUM LIGHTWEIGHT LAP INSTRUMENT STERILIZATION & STORAGE CONTAINER FOR 33CM & 45CM INSTRUMENTS; HOLDS UP TO (16) 5MM & 10MM DIAMETER INSTRUMENTS (21" X 10" X 6")
----------------------	--

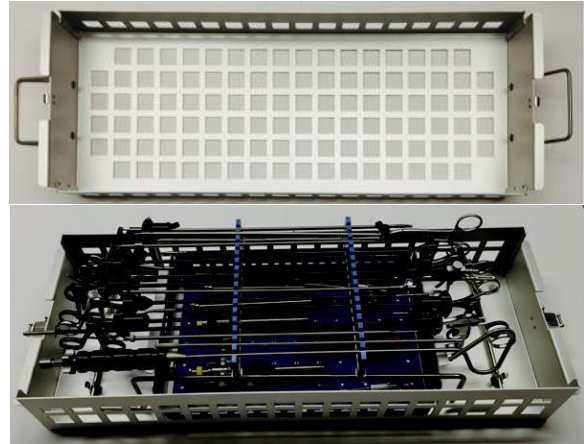

LIST NO. 52038-49	ALUMINUM LIGHTWEIGHT LAP INSTRUMENT STERILIZATION & STORAGE CONTAINER FOR 33CM & 45CM INSTRUMENTS; HOLDS UP TO (16) 5MM & 10MM DIAMETER INSTRUMENTS ALONG WITH TAKE OUT TRAY FOR MISC. INSTRUMENTS (21" X 10" X 6")
----------------------	---



LIST NO. 52038-53	LAP INSTRUMENT STERILIZATION & STORAGE CONTAINER FOR 33CM INSTRUMENTS; HOLDS UP TO (12) 5MM & 10MM DIAMETER INSTRUMENTS (MOLDED MEDICAL GRADE POLYMER, 21" X 10" X 4")
----------------------	--

LIST NO. 52038-54	LAP INSTRUMENT STERILIZATION & STORAGE CONTAINER FOR 45CM INSTRUMENTS; HOLDS UP TO (16) 5&10MM DIAMETER INSTRUMENTS (MOLDED MEDICAL GRADE POLYMER, 25" X 12" X 5")
----------------------	--



LIST NO. 52038-51	LAP INSTRUMENT CONTAINER W/ REMOVABLE TRAY FOR 33CM INSTRUMENT HOLDS UP TO (12) 5MM & 10MM DIAMETER INSTRUMENTS (MOLDED MEDICAL GRADE POLYMER & SILICONE, 21" X 10" X 7")
----------------------	---

LIST NO. 52038-52	LAP INSTRUMENT CONTAINER W/ REMOVABLE TRAY FOR 45CM INSTRUMENTS; HOLDS UP TO (10) 5&10MM DIAMETER INSTRUMENTS (MOLDED MEDICAL GRADE POLYMER & SILICONE, 26" X 9 1/2" X 7")
----------------------	--



LIST NO. 52037-00-B4	ALUMINUM STERILIZATION CONTAINER 25" X 5" X 2", W/ 4 BARS
-------------------------	--

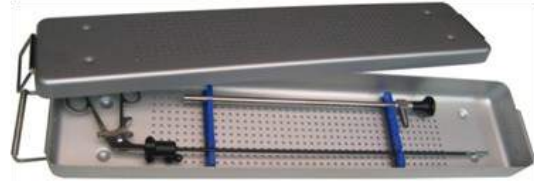

LIST NO. 52037-00-B2	ALUMINUM STERILIZATION CONTAINER 25" X 5" X 2", W/ 2 BARS
-------------------------	--



LIST NO. 52037-07	THERMOPLASTIC STERILIZATION & STORAGE CONTAINER W/ SILICONE MOUNTING BARS FOR MULTIPLE LAP/HYSTO/CYSTO SCOPE OR SINGLE HYST/CYST SHEATH SYSTEM, (MOLDED MEDICAL-GRADE POLYMER & SILICONE), 18"L X 7"W X 1.5"H
----------------------	---



LIST NO. 52037-06	THERMOPLASTIC STERILIZATION & STORAGE CONTAINER FOR 2 LAP/HYSTO/CYSTO SCOPES OR SINGLE HYST/CYST SHEATH SYSTEM, (MOLDED MEDICAL-GRADE POLYMER & SILICONE), 18"L X 3"W X 1.5"H
----------------------	---

**ALSO AVAILABLE, BUT NOT PICTURED...**

LIST NO. 52037-05	THERMOPLASTIC STERILIZATION & STORAGE CONTAINER FOR SINGLE LAP/HYSTO/CYSTO SCOPE OR SINGLE HYST/CYST SHEATH SYSTEM (MOLDED MEDICAL-GRADE POLYMER & SILICONE) 18"L X 3"W X 1.5"H
LIST NO. 52037-08	THERMOPLASTIC STERILIZATION & STORAGE CONTAINER (DOUBLE HEIGHT) FOR MULTIPLE LAP/HYSTO/CYSTO SCOPE OR SINGLE HYST/CYST SHEATH SYSTEM, (MOLDED MEDICAL-GRADE POLYMER & SILICONE), 18"L X 7"W X 3"H
LIST NO. 52038-15	STERILIZATION & STORAGE CONTAINER FOR EXTRA-LONG SCOPE & CABLE, 25" X 6" X 1.5" (MOLDED MEDICAL-GRADE POLYMER & SILICONE); HOLDS 2 SCOPES UP TO 50CM LONG
LIST NO. 52037-11	MUSLIN CLOTH FOR 52037-00 & 52037-01 CONTAINER

	<u>Length</u>	<u>Insert &amp; Tube</u>	<u>Style C:</u>
3.5MM Ø, STANDARD GRASPER/DISSECTOR WITH SPOON	20 CM	53520-02IT	53520-02C
	30 CM	53530-02IT	53530-02C
	45 CM	53545-02IT	53545-02C
3.5MM Ø, STANDARD GRASPER/DISSECTOR	20 CM	53520-03IT	53520-03C
	30 CM	53530-03IT	53530-03C
	45 CM	53545-03IT	53545-03C
3.5MM Ø, MARYLAND GRASPER/DISSECTOR	20 CM	53520-06IT	53520-06C
	30 CM	53530-06IT	53530-06C
	45 CM	53545-06IT	53545-06C
3.5MM Ø, MIXTER GRASPER/DISSECTOR RIGHT ANGLE	20 CM	53520-07IT	53520-07C
	30 CM	53530-07IT	53530-07C
	45 CM	53545-07IT	53545-07C
3.5MM Ø, HUNTER/FENESTRATED DEBAKEY GRASPER	20 CM	53520-58IT	53520-58C
	30 CM	53530-58IT	53530-58C
	45 CM	53545-58IT	53545-58C
3.5MM Ø, NEEDLE-NOSE GRASPER/DISSECTOR	20 CM	53520-10IT	53520-10C
	30 CM	53530-10IT	53530-10C
	45 CM	53545-10IT	53545-10C
3.5MM Ø, COBRA GRASPER, DOUBLE-ACTION	20 CM	53520-15IT	53520-15C
	30 CM	53530-15IT	53530-15C
	45 CM	53545-15IT	53545-15C
3.5MM Ø, BABCOCK GRASPER, FENESTRATED TIP	20 CM	53520-16IT	53520-16C
	30 CM	53530-16IT	53530-16C
	45 CM	53545-16IT	53545-16C
3.5MM Ø, ATRAUMATIC ALLIS GRASPER, SHORT VERSION, SERRATED W/ DOUBLE ROW OF TEETH, DOUBLE-ACTION	20 CM	53520-119IT	53520-119C
	30 CM	53530-119IT	53530-119C
	45 CM	53545-119IT	53545-119C
3.5MM Ø, DOUBLE CUP FUNDUS MAXI GRASPER	20 CM	53520-26IT	53520-26C
	30 CM	53530-26IT	53530-26C
	45 CM	53545-26IT	53545-26C
3.5MM Ø, ENDO CLINCH FENESTRATED GRASPER	20 CM	53520-27IT	53520-27C
	30 CM	53530-27IT	53530-27C
	45 CM	53545-27IT	53545-27C
3.5MM Ø, ALLIGATOR GRASPER, RETRO FACING TEETH, DOUBLE-ACTION	20 CM	53520-29IT	53520-29C
	30 CM	53530-29IT	53530-29C
	45 CM	53545-29IT	53545-29C
3.5MM Ø, FENESTRATED GRASPER, 16 MM DBL-ACTION JAW	20 CM	53520-38IT	53520-38C
	30 CM	53530-38IT	53530-38C
	45 CM	53545-38IT	53545-38C

**Recommended Handles**



*Type 9:  
Lightweight  
Carbon-Fiber w/  
RF Post. w/ Large  
Finger Loops*

**OR**







*Type 17:  
Lightweight Carbon  
-Fiber w/ RF Post*

**OR**



*Type 18:  
Carbon-Fiber w/  
RF Post. Ratchet /  
Ratchet Defeating*

	<u>Length</u>	<u>Insert &amp; Tube</u>	<u>Style C:</u>
 3.5MM Ø, HOOK SCISSORS, SINGLE-ACTION	20 CM	53520-60IT	53520-60C
	30 CM	53530-60IT	53530-60C
	45 CM	53545-60IT	53545-60C
 3.5MM Ø, METZENBAUM SCISSORS, CURVED	20 CM	53520-66IT	53520-66C
	30 CM	53530-66IT	53530-66C
	45 CM	53545-66IT	53545-66C
 3.5MM Ø, METZENBAUM SCISSORS, CURVED, FINE SERRATED	20 CM	53520-166IT	53520-166C
	30 CM	53530-166IT	53530-166C
	45 CM	53545-166IT	53545-166C
 3.5MM Ø, PERITONEAL SCISSORS, SINGLE-ACTION	20 CM	53520-67IT	53520-67C
	30 CM	53530-67IT	53530-67C
	45 CM	53545-67IT	53545-67C



Type 17:  
Lightweight Carbon-Fiber w/ RF Post

OR



Type 9:  
Lightweight Carbon-Fiber w/ RF Post w/ Large Finger Loops



<u>TIP DESIGN</u>		<u>20 CM SHAFT</u>	<u>30 CM SHAFT</u>	<u>45 CM SHAFT</u>
	STRAIGHT 8 MM TC TIP	LIST NO. 53520-77	LIST NO. 53530-77	LIST NO. 53545-77

Features:

- Shorter, lightweight double-action axial handle
  - Solid quick thumb release
- The handle gives the user the most precise, ergonomically hand manipulation
  - Completely reusable



	<u>Length</u>	<u>Insert &amp; Tube</u>	<u>Style C:</u>
	3MM Ø, STANDARD GRASPER/DISSECTOR WITH SPOON	20 CM	53020-02IT 53020-02C
		30 CM	53030-02IT 53030-02C
		45 CM	53045-02IT 53045-02C
	3MM Ø, BULLET-NOSE GRASPER/DISSECTOR WITH SPOON	20 CM	53020-04IT 53020-04C
		30 CM	53030-04IT 53030-04C
		45 CM	53045-04IT 53045-04C
	3MM Ø, MARYLAND GRASPER/DISSECTOR	20 CM	53020-06IT 53020-06C
		30 CM	53030-06IT 53030-06C
		45 CM	53045-06IT 53045-06C
	3MM Ø, NEEDLE-NOSE GRASPER/DISSECTOR	20 CM	53020-10IT 53020-10C
		30 CM	53030-10IT 53030-10C
		45 CM	53045-10IT 53045-10C
	3MM Ø, CLAW GRASPER, 2 X 3 TEETH, SINGLE-ACTION	20 CM	53020-36IT 53020-36C
		30 CM	53030-36IT 53030-36C
		45 CM	53045-36IT 53045-36C
	3MM Ø, ATRAUMATIC FENESTRATED GRASPER, CURVED, 16 MM DBL-ACTION JAW	20 CM	53020-37IT 53020-37C
		30 CM	53030-37IT 53030-37C
		45 CM	53045-37IT 53045-37C
	3MM Ø, "MCKERNAN" STYLE FUNDUS MAXI GRASPER	20 CM	53020-126IT 53020-126C
		30 CM	53030-126IT 53030-126C
		45 CM	53045-126IT 53045-126C
	3MM Ø, BIOPSY SPOON FORCEPS, W/ TOOTH (SEMM-TYPE), DBL-ACTION	20 CM	53020-68IT 53020-68C
		30 CM	53030-68IT 53030-68C
		45 CM	53045-68IT 53045-68C
	3MM Ø, BIOPSY SPOON FORCEPS, DBL-ACTION	20 CM	53020-70IT 53020-70C
		30 CM	53030-70IT 53030-70C
		45 CM	53045-70IT 53045-70C
	3MM Ø, HOOK SCISSORS, SINGLE-ACTION	20 CM	53020-60IT 53020-60C
		30 CM	53030-60IT 53030-60C
		45 CM	53045-60IT 53045-60C
	3MM Ø, METZENBAUM SCISSORS, CURVED	20 CM	53020-66IT 53020-66C
		30 CM	53030-66IT 53030-66C
		45 CM	53045-66IT 53045-66C
	3MM Ø, PERITONEAL SCISSORS, SINGLE-ACTION	20 CM	53020-67IT 53020-67C
		30 CM	53030-67IT 53030-67C
		45 CM	53045-67IT 53045-67C
	3MM Ø, MICRO TIP SCISSORS, CURVED, SINGLE-ACTION	20 CM	53020-62IT 53020-62C
		30 CM	53030-62IT 53030-62C
		45 CM	53045-62IT 53045-62C

Recommended Handles



Type 9:  
Lightweight  
Carbon-Fiber w/  
RF Post, w/ Large  
Finger Loops

OR



Type 17:  
Lightweight Carbon  
-Fiber w/ RF Post

OR







Type 18:  
Carbon-Fiber w/  
RF Post, Ratchet /  
Ratchet Defeating



Features:

- Shorter, lightweight double-action axial handle
  - Solid quick thumb release
- The handle gives the user the most precise, ergonomically hand manipulation
  - Completely reusable

TIP DESIGN		20 CM SHAFT	30 CM SHAFT	45 CM SHAFT
	STRAIGHT 8 MM TC TIP	LIST NO. 53020-77	LIST NO. 53030-77	LIST NO. 53045-77
	CURVED LEFT TC TIP	LIST NO. 53020-78	LIST NO. 53030-78	LIST NO. 53045-78
	CURVED RIGHT TC TIP	LIST NO. 53020-79	LIST NO. 53030-79	LIST NO. 53045-79
	SELF-RIGHTING NEEDLE TIP	LIST NO. 53020-82	LIST NO. 53030-82	LIST NO. 53045-82

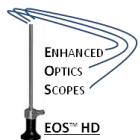

LIST NO.	DESCRIPTION
52930-00	EOS HD MINI LAPAROSCOPE, 0 DEGREE STANDARD EYE PIECE, 2.9 MM DIA., 30 CM LENGTH, PREMIUM ROD LENS SYSTEM- AUTOCLAVEABLE



STANDARD



THREADED

53070-01	3 MM DIA., TROCAR SLEEVE, STAINLESS STEEL WITH TRUMPET VALVE, 70MM LENGTH
53130-02	3 MM DIA., TROCAR SLEEVE, STAINLESS STEEL WITH TRUMPET VALVE, 103MM LENGTH
54070-01	4MM DIA., TROCAR SLEEVE, STAINLESS STEEL WITH TRUMPET VALVE, 70MM LENGTH
54130-02	4MM DIA., TROCAR SLEEVE, STAINLESS STEEL WITH TRUMPET VALVE, 103MM LENGTH

53070-01T	3MM DIA., TROCAR SLEEVE, STAINLESS STEEL WITH TRUMPET VALVE, THREADED SLEEVE, 70MM LENGTH
53130-02T	3 MM DIA., TROCAR SLEEVE, STAINLESS STEEL WITH TRUMPET VALVE, THREADED SLEEVE, 103MM LENGTH
54070-01T	4MM DIA., TROCAR SLEEVE, STAINLESS STEEL WITH TRUMPET VALVE, THREADED SLEEVE, 70MM LENGTH
54130-02T	4MM DIA., TROCAR SLEEVE, STAINLESS STEEL WITH TRUMPET VALVE, 103MM LENGTH



THERMOPLASTIC, SMOOTH SLEEVE



THERMOPLASTIC, THREADED SLEEVE

53070-03	3MM, 70MM "LITE" THERMOPLASTIC TROCAR SLEEVE
53130-03	4MM, 70MM "LITE" THERMOPLASTIC TROCAR SLEEVE
54070-03	3MM, 103MM "LITE" THERMOPLASTIC TROCAR SLEEVE
54130-04	4MM, 103MM "LITE" THERMOPLASTIC TROCAR SLEEVE

53070-03T	3MM, 70MM "LITE" THERMOPLASTIC TROCAR SLEEVE, THREADED
53130-03T	4MM, 70MM "LITE" THERMOPLASTIC TROCAR SLEEVE, THREADED
54070-03T	3MM, 103MM "LITE" THERMOPLASTIC TROCAR SLEEVE, THREADED
54130-04T	4MM, 103MM "LITE" THERMOPLASTIC TROCAR SLEEVE, THREADED



DIAMETER	70MM	103MM
3MM	53070-05	53103-05
4MM	54070-05	54103-05



DIAMETER	70MM	103MM.
3MM	53070-06	53103-06
4MM	54070-06	54103-06



DIAMETER	70MM	103MM.
3MM	53070-07	53103-07
4MM	54070-07	54103-07

*We offer complete solution for Electrosurgical Accessories for hospital at the right price.*

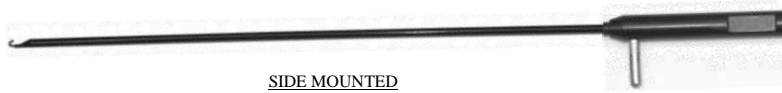

SIDE MOUNTED  
RF CONNECTOR



KNIFE

20CM	LIST NO. 53020-25
30CM	LIST NO. 53030-25
45CM	LIST NO. 53045-25



CONE

20CM	LIST NO. 53020-26
30CM	LIST NO. 53030-26
45CM	LIST NO. 53045-26



"L" HOOK

20CM	LIST NO. 53020-27
30CM	LIST NO. 53030-27
45CM	LIST NO. 53045-27



"J" HOOK

20CM	LIST NO. 53020-28
30CM	LIST NO. 53030-28
45CM	LIST NO. 53045-28



SPATULA

20CM	LIST NO. 53020-29
30CM	LIST NO. 53030-29
45CM	LIST NO. 53045-29



BALL

20CM	LIST NO. 53020-30
30CM	LIST NO. 53030-30
45CM	LIST NO. 53045-30



NEEDLE

20CM	LIST NO. 53020-31
30CM	LIST NO. 53030-31
45CM	LIST NO. 53045-31



LIST NO. 53020-15	2.8MM, 20CM IRRIGATION / SUCTION SYSTEM W/ DUAL-VALVE HANDLE
LIST NO. 53030-15	2.8MM, 30CM IRRIGATION / SUCTION SYSTEM W/ DUAL-VALVE HANDLE



LIST NO. 53020-25	2.8MM, 20CM IRRIGATION / SUCTION SYSTEM W/ TWO-WAY LEVER VALVE, CANNULA W/ CENTRAL & LATERAL DISTAL OPENINGS
LIST NO. 53030-25	2.8MM, 30CM IRRIGATION / SUCTION SYSTEM W/ TWO-WAY LEVER VALVE, CANNULA W/ CENTRAL & LATERAL DISTAL OPENINGS



LIST NO. 53030-24	LAVAGE CANNULA w/ 3-WAY STOPCOCK, POOLE SUCTION TIP w/ LATERAL HOLES, 30CM, 3MM DIA
-------------------	---



LIST NO. 53030-22	ASPIRATION NEEDLE, 30CM, 3MM DIA., 15 GAUGE NEEDLE STANDARD (SPECIFY *18 GA. - 25 GA.)
-------------------	--